

**Most Preferred Partner
for Sensing and Control**



Explore Intelligent Technologies

Sensors and Embedded Controllers
for Automotive and Industrial 2015







Company 4 – 17

Milestones5
Semiconductor Technology6
Quality Principles7
Automotive Applications10
Industrial Applications14
Overview of Major Product Families16

Hall-Effect Sensors 18 – 40

Introduction18
Selection Guide Hall Sensors20
HAL 1xy22
HAL 2xy23
HAL 300, HAL 32024
HAL 5xy25
HAL 7xy26
HAL 100227
HAL 15xy28
HAL 4xy29
HAL 81x, HAL 82530
HAL 83x, HAC 83031
HAL 85x32
HAL 88033
HAL 182x34
HAL 24xy, HAR 24xy35
HAL 28xy36
HAL 36xy38
HAL 37xy39
HAL 38xy40

Current Sensors 41

CUR 3105, CUR 311541
------------------------------	-----

Tool Chain for Hall Sensors and Current Sensors42
--	-----

Gas Sensors 43

Introduction43
GAS 86xyB44
Tool Chain GAS 86xyB / USB Demo Kit46

Embedded Motor Controllers 47–52

Introduction47
HVC 4223F48
HVC 2480B49
Functions50
Motor Control Applications51
Tool Chain for Embedded Controllers52

Package Information 53



Matthias Bopp, CEO

Dear customer,

What constitutes true pioneering work? To give an answer, we need to ask more questions. What does Micronas stand for? Power of innovation, certainly. Quality "Made in Germany," no doubt. But there is also the responsibility arising from it – for our environment and the people around us. Economic efficiency and environmental protection are inextricably linked with Micronas.

Our identity: intelligent sensor system solutions. Our objective: products which are unique. Our vision: technology making history. But is all this sufficient to make us fit for the future? Our approach: using modern technology sensibly and satisfying the claim of true innovation – for today and tomorrow. This is why we start with the developments and tendencies in the automotive industry. Our sensors and embedded motor controllers fulfil our OEM's needs and expectations: reducing fuel consumption in cars and at the same time reducing CO₂ emissions. We offer our customers solutions which can be easily integrated into the target application; cost-effective, space-saving and efficient. With intelligent functions which make life easier and which make motoring more convenient and safer. And with an unparalleled quality claim. All this is Micronas. For us, combining economic efficiency and sustainability is no contradiction, but motivation.

Yours most truly

A handwritten signature in black ink, which appears to read "Matthias Bopp". The signature is fluid and cursive, written in a professional style.

Matthias Bopp
CEO Micronas

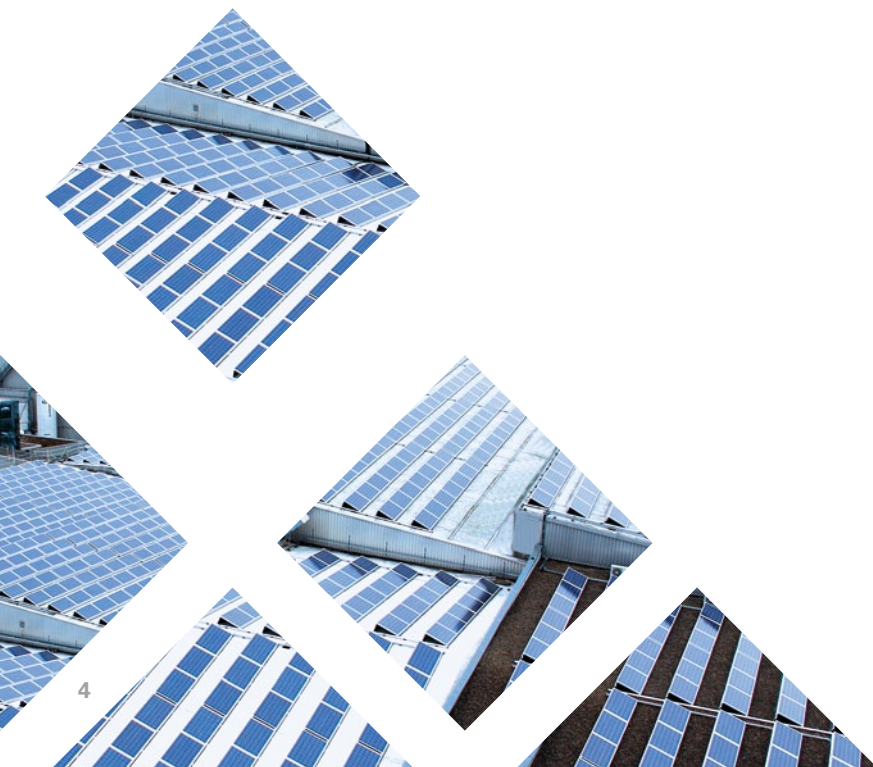

Milestones

Once pioneering CMOS-based Hall-effect sensors, Micronas offers its customers today the world's broadest range of Hall-effect sensors. Micronas' expertise combines perfectly with its CMOS and mixed-signal design resources to create accurate, intelligent sensors for a broad range of Automotive and Industrial applications. Starting the track record in 1966 with the first tuner diode, Micronas today offers a very large product portfolio for innovative sensor-based system solutions.

HAR 24xy Dual-Die Linear Hall-effect sensor family integrates two fully independent automotive-qualified dies into a small SMD package.

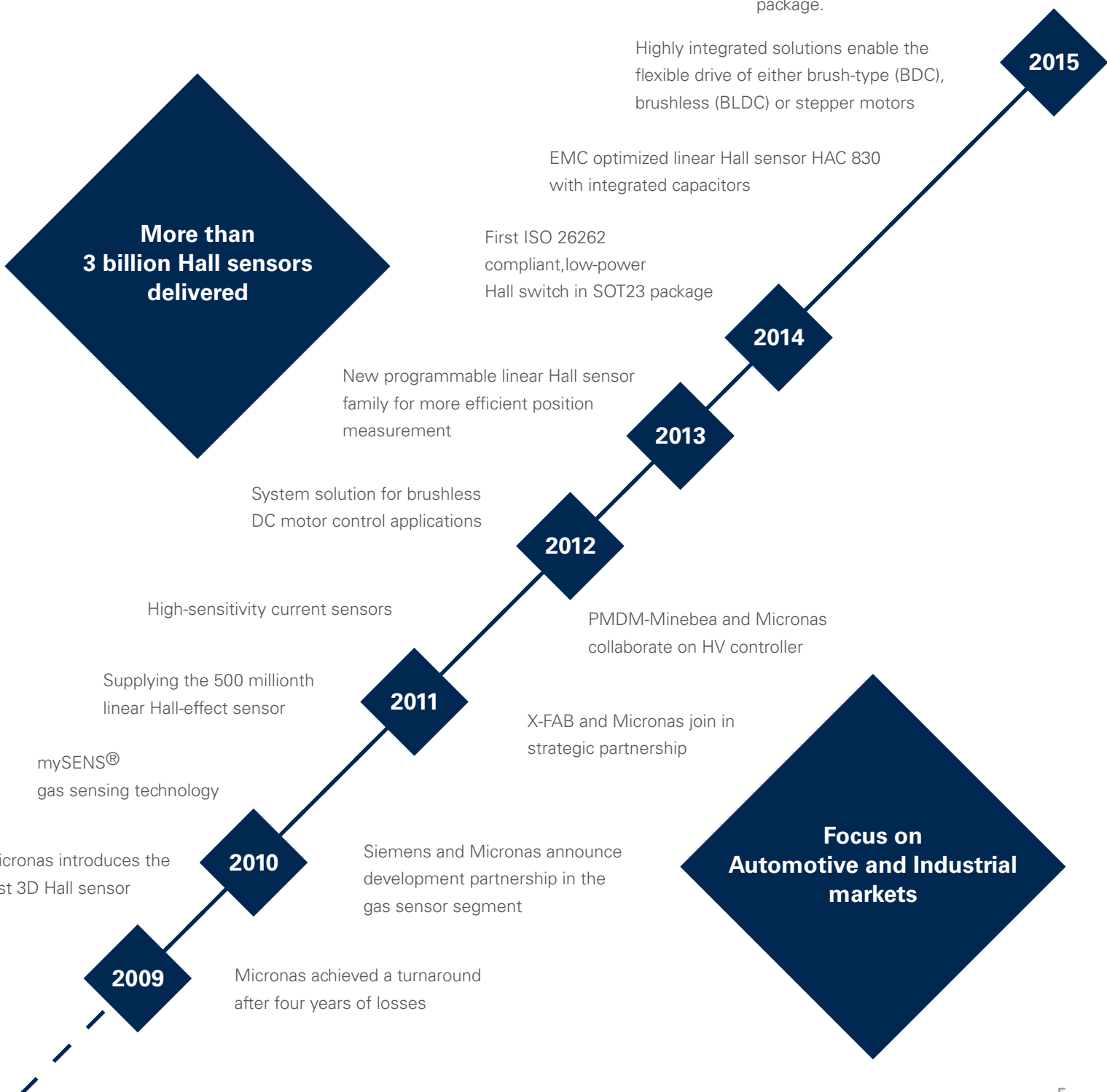

Tiny structures – highest performance

Since the invention of the transistor, the circuit electronics has experienced a rapid development. Today, the micro system technology is considered a key technology of the future. We at Micronas manufacture our semiconductor devices based on the CMOS technology (Complementary Metal Oxide Semiconductor). Fast, powerful, intelligent – and yet so tiny. The structures of our field-effect transistors are less than one micron wide and form the basis of our sensors and embedded controllers. Developed by top engineers, our products are used everywhere, where measurements with high precision and high reliability are required.

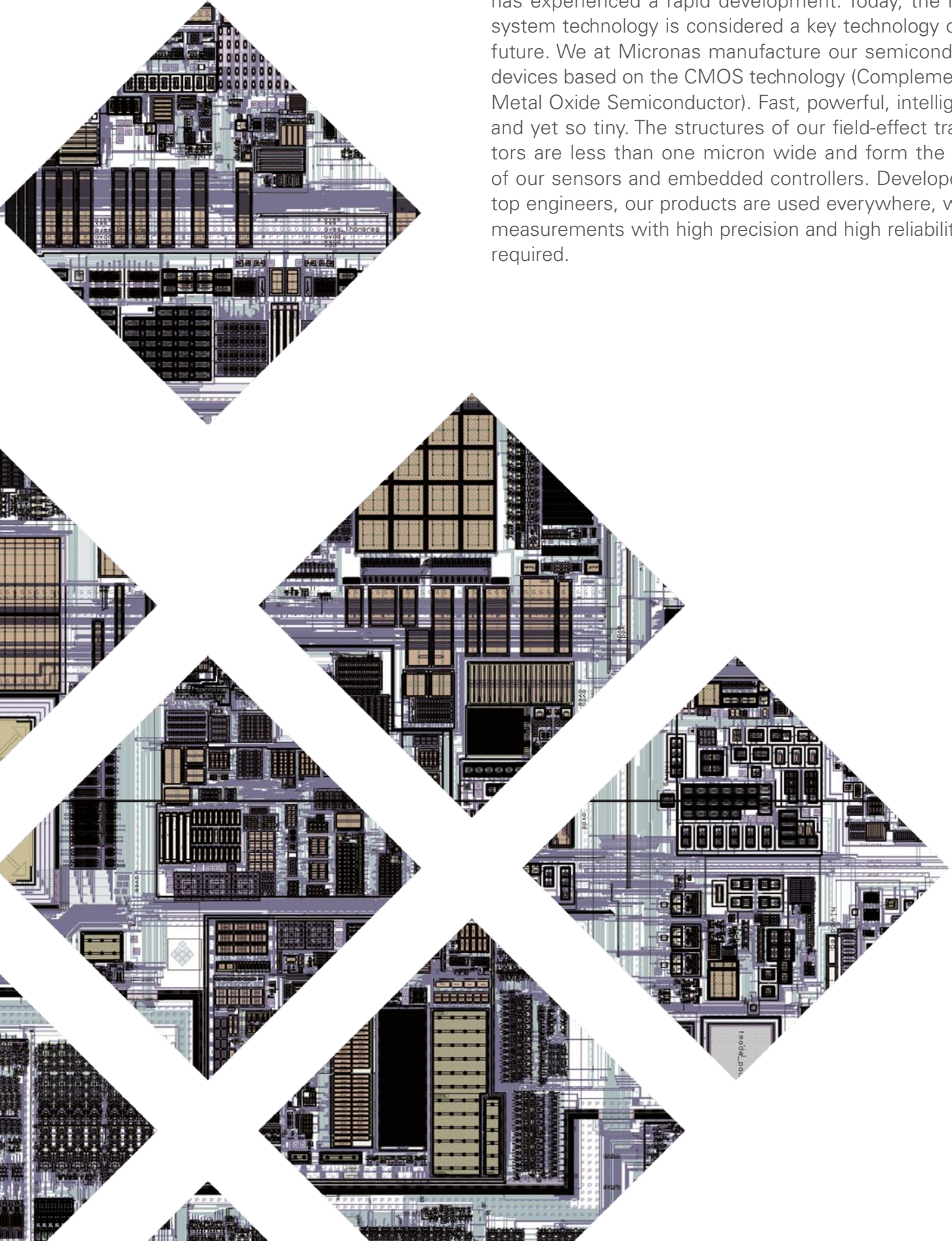

Quality has Top Priority

We do not make compromises and therefore aim to zero ppm. The success and the satisfaction of our customers is our measure of quality. We deliver our customers with high-grade products at reasonable prices and with best support. Therefore, we make a great effort to ensure highest quality and reliability. The immediate reaction to quality matters has top priority. Everyone here at Micronas is brought to report quality issues before they could affect our products corresponding to our principle: Prevention instead of Correction.



Wolfgang Bossinger,
Vice President Quality

„We do not only fulfil the strict policies of the Automotive industry, but we are also striving to exceed them. Our quality consists of more than just a policy. It induces a good feeling when you get into your vehicle.“



ISO 14001 Certificate



AAA Certificate



AEO Certificate



ISO 9001 Certificate



ISO 16949 Certificate



EMAS Certificate

Automotive Applications

In automotive electronics, Micronas is focusing both on highly integrated control systems for car interior applications, as well as on sensor systems for a wide range of applications. They require on one hand rather simple Hall switches to detect a position and on the other hand quite complex linear Hall-effect sensors for the measurement of distances or rotational movements.

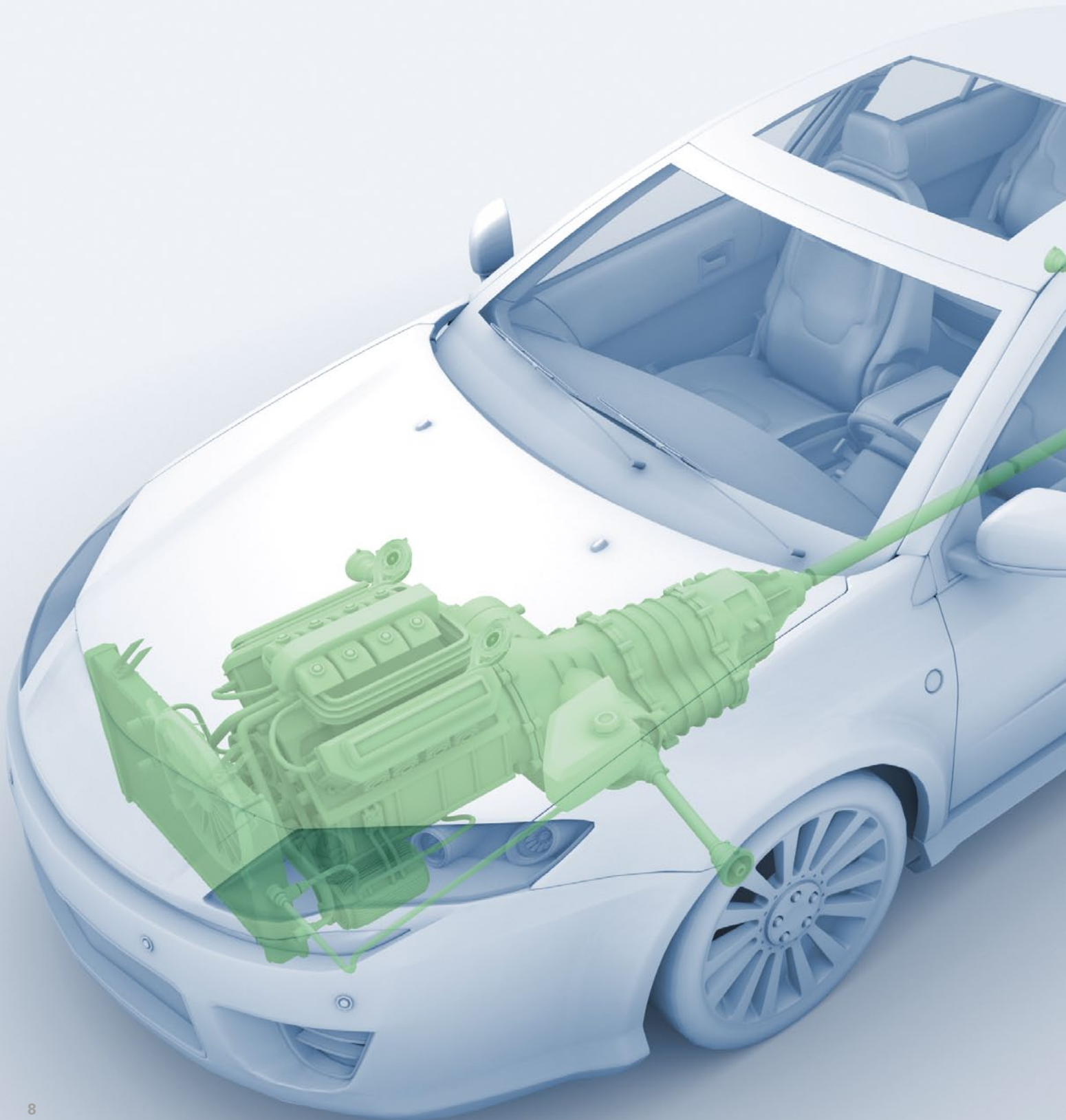

Powertrain

An increased demand for high energy efficiency and CO₂ reduction asks for optimized sensor and actuator solutions. Micronas aims to provide solutions for all powertrain applications from battery management to exhaust valves through shift lever and pedal position sensors. Micronas develops high accuracy sensors designed to withstand harsh under-the-hood environments: insensitive to vibrations, temperature drift and dirt.

Examples for automotive applications using Micronas products

Active Pedal – Clutch

Modern systems like cruise-control, electrical parking brake, start-stop functions, start lock, and torque adjustment require a displacement sensor on the clutch master cylinder. The displacement sensor measures up to 40 mm movement. Two-dimensional Hall-effect sensors are a robust and cost-effective solution for this task.

Sensor Type: 2D
 • HAL 37xy

Active Pedal – Acceleration

Electronic throttle control replaces the mechanical link between acceleration pedal and throttle valve (drive-by-wire). Linear Hall sensors with analog output are used to detect pedal courses with small angle (<20°). They ensure reliability and high accuracy, especially to detect the accelerator idle position.

Sensor Type: Linear
 • HAL 830
 • HAL 2420

Powertrain Valves – Throttle

The throttle valve directly regulates the amount of air entering the engine (gasoline internal combustion engine) or is used to generate the intake manifold vacuum (diesel engine). Linear or 2D Hall sensors with analog output are used to detect the throttle position.

Sensor Type: 2D, Linear
 • HAC 830
 • HAL 2425
 • HAL 37xy

Powertrain Valves – EGR

EGR works by recirculating a portion of the engine's exhaust gas back into the engine cylinders leading to reduced fuel consumption of the vehicle and less CO emissions. Sensors based on the 2D HAL technology provide an optimal solution for the measurement of the actual valve position being robust against air gap and temperature variations.

Sensor Type: 2D
 • HAL 37xy

Powertrain Valves – Thermal Valves

Sensors based on the 2D HAL technology provide an optimal solution for the measurement of the actual valve position being robust against air gap and temperature variations. HVC all-in-one integrated solutions offer a very small footprint while matching the power requirement for a BLDC drive in a single chip without the need for an external MOSFET.

Sensor Type: 2D
 Controller Type: HVC
 • HAL 37xy
 • HVC 2480B
 • HVC 4223F

Battery Management

Battery located under the engine hood. A high-precision current sensor is required for battery management system structuring SOC (State of Charge) and SOH (State of Health) estimation. A current sensor features low output voltage drifts over temperature and multiple programmable magnetic field range.

Sensor Type: Current Sensor, Linear
 • CUR 3115
 • HAL 2425

Gear position

Hall switches are used for any type of pumps, e.g. for water and oil, to detect the position of the impeller. To reduce the overall current consumption, the HAL 1502 3-wire version with only 1.6 mA is preferred. HVC products are also very well suited to provide efficient BLDC drives for auxiliary pumps.

Sensor Type: Linear
 • HAL 182x
 • HAL 85x
 • HAL 24xy

Water/Oil Pumps

Hall switches are used for any type of pumps, e.g. for water and oil, to detect the position of the impeller. To reduce the overall current consumption, the HAL 1502 3-wire version with only 1.6 mA is preferred. HVC products are also very well suited to provide efficient BLDC drives for auxiliary pumps.

Sensor Type: Switch
 Controller Type: HVC
 • HAL 15xy 2-wire
 • HVC 2480B

Liquid Level

Hall sensors are used to detect liquid levels, for instance the gasoline level inside the tank. Linearization setpoints are required.

Sensor Type: Linear, 2D
 • HAL 85x
 • HAL 2425
 • HAL 37xy

Shift Lever Position

The gear shift application setup can be realized either as extremely price-attractive solution by using several Hall switches placed at each gear position or by a highly integrated solution using only one 2D sensor which is capable of measuring extended distances.

Sensor Type: Switch, 2D
 • HAL 15xy 3-wire
 • HAL 37xy

Turbo Charger

Linear Hall sensors with analog output are used to detect the position of a valve which blocks or increases the air flow through the turbine. They ensure reliability and high accuracy together with small offset and sensitivity drift over lifetime and temperature.

Sensor Type: Linear, 2D
 • HAC 830
 • HAL 2425
 • HAR 2835
 • HAL 37xy

Automotive Applications

Chassis & Safety

Both comfort and safety requirements are driving the trends towards higher safety integration and safe exchange of sensor information between braking, suspension and steering modules. Micronas provides highly reliable solutions for those systems and develops next generation components addressing the needs for higher bandwidth and more functional safety.

Micronas offers a wide portfolio of switches, linear and direct angle sensors with diversified communication channels and redundancy levels.

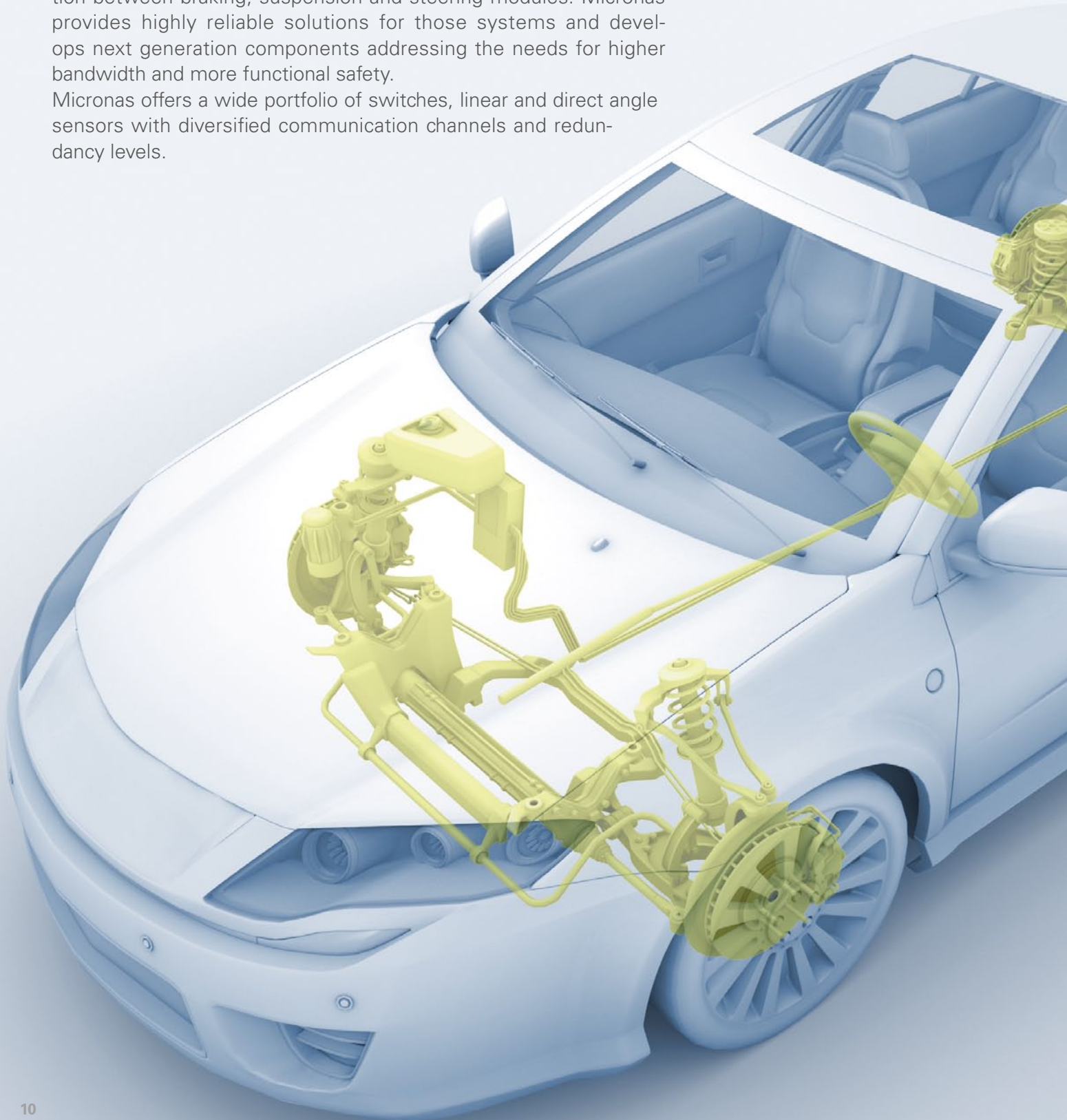

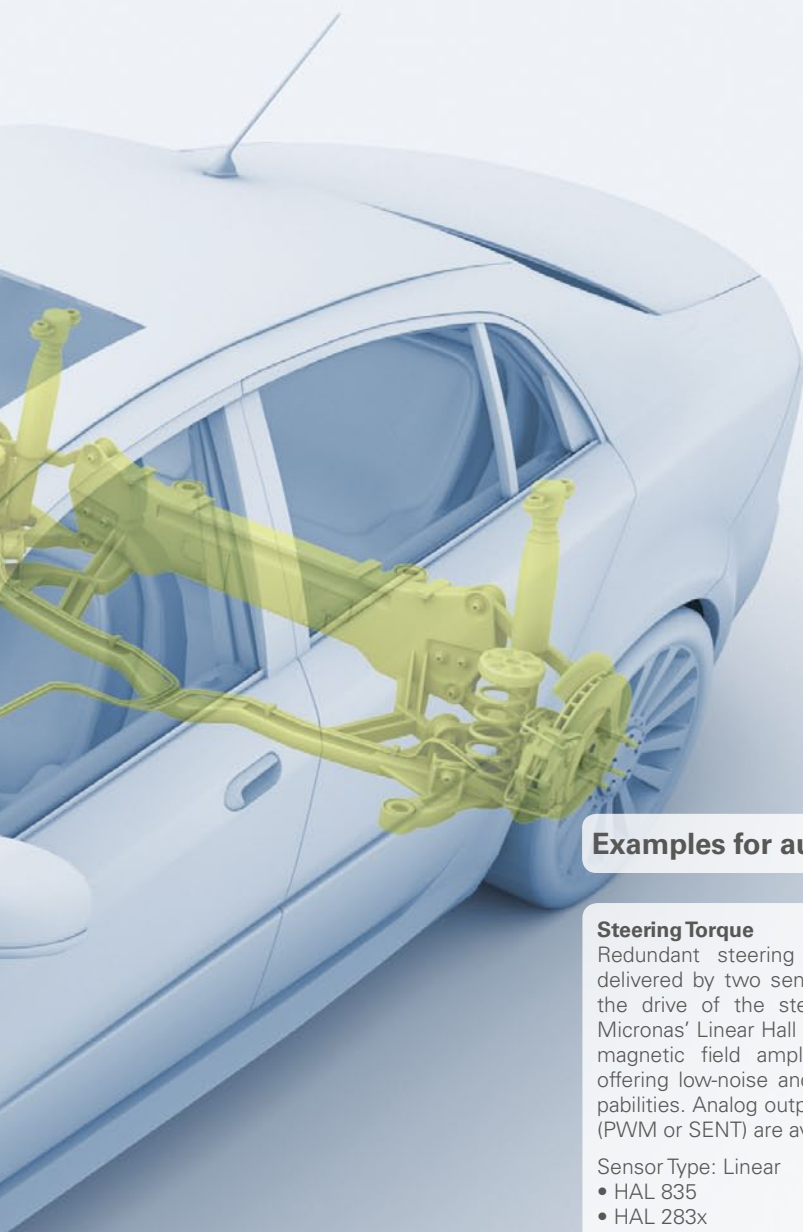

Examples for automotive applications using Micronas products

Steering Torque

Redundant steering torque information delivered by two sensors is essential for the drive of the steering assist motor. Micronas' Linear Hall sensors are used for magnetic field amplitude measurement offering low-noise and low-offset drift capabilities. Analog output and digital output (PWM or SENT) are available.

Sensor Type: Linear

- HAL 835
- HAL 283x

Steering Angle

2D Hall-effect sensors measuring angles up to 360° are a cost-efficient solution for a contactless steering position measurement. The devices support state-of-the-art interfaces like PWM and SENT.

Sensor Type: 2D

- HAL 3735

Steering Motor – BLDC Motor

As part of the power steering system, Hall switches are used for BLDC motor commutation. To reduce the overall current consumption, the HAL 1502 3-wire version with only 1.6 mA is preferred.

Sensor Type: Switch

- HAL 15xy 3-wire

Chassis Position Sensor

The chassis position sensors (CPS) are located near the vehicle's front and rear axes. They determine the vehicle's current position and adjust the range of the main headlights accordingly. CPS requires angular sensors with full 360° measurement range, which is usually split into four segments of 90° or three of 120°. The interface is usually analog, PWM, or recently also PSI5.

Sensor Type: 2D

- HAL 3715

Braking Pedal

A 2-wire unipolar Hall switch or a 2D Hall sensor can be used to determine when the pedal has passed a certain position whereas the 2D sensor measures the complete angle/movement of the pedal, providing higher safety.

Sensor Type: Switch, 2D

- HAL 15xy 2-wire
- HAL 37xy

Automotive Applications

Body & Comfort

Important electrification trend in the vehicle body compartment. Contactless sensors and electric motors are replacing mechanical and hydraulic systems for higher comfort and better reliability. Micronas has the largest Hall-effect sensor portfolio to address the wide diversity of requirements in those applications and next generation components addressing the needs for lower power consumption and system cost efficiency. Micronas provides also fully integrated servo-drive controllers for BLDC and stepper motors as well as switches and direct angle sensors for motor position detection.

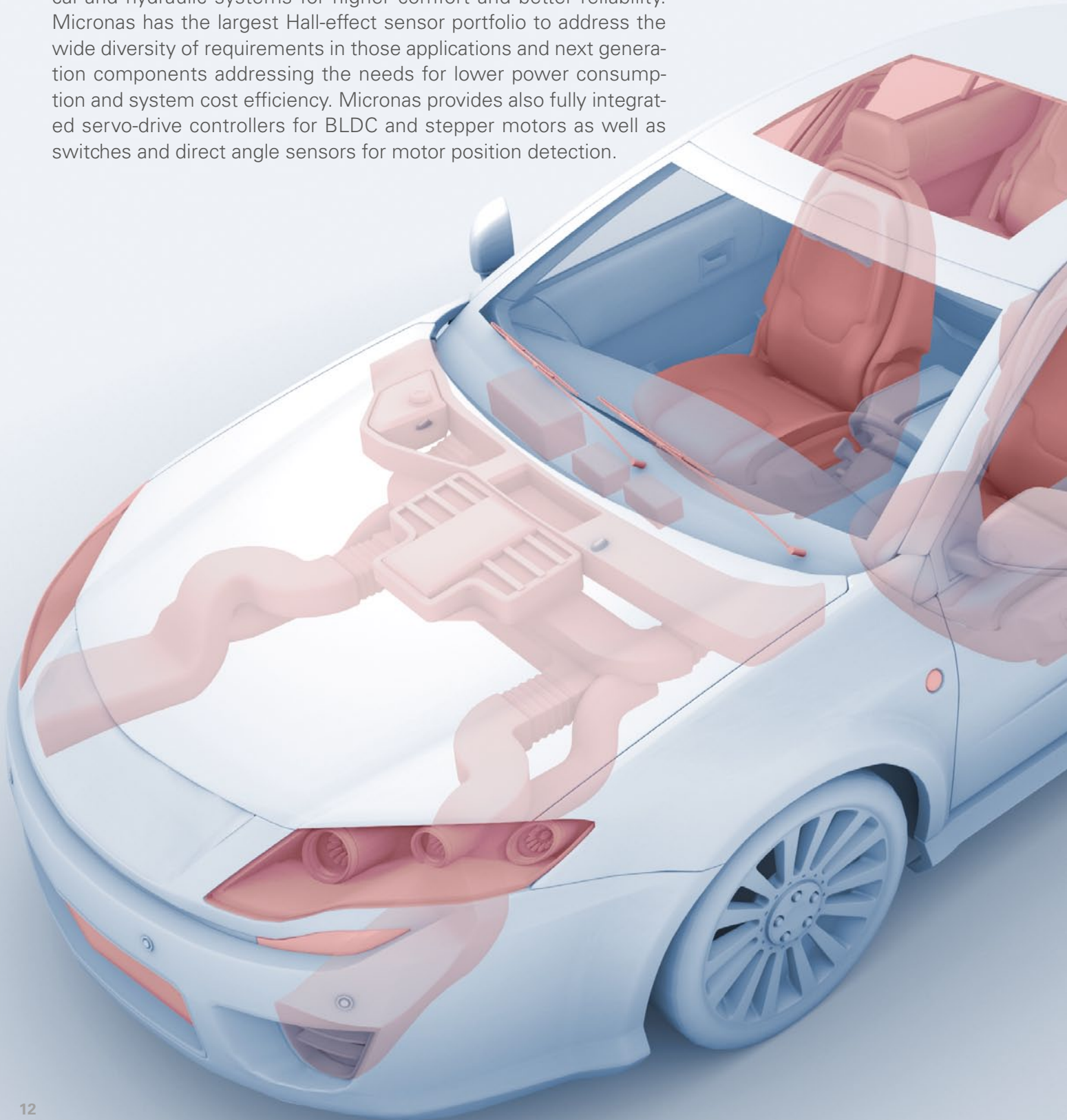



Examples for automotive applications using Micronas products

Sun Roof / Window Lifter

Single or Dual (HAL 7xy) Hall plate switches are used to determine the position of the window pane by measuring the motion direction, as well as counting the revolutions of the window lifter motor.

Sensor Type: Switch

- HAL 15xy 3-wire
- HAL 7xy

Door Lock

Hall switches are used to detect whether the car doors are locked or not. By skipping the third wire, the 2-wire sensor type is preferred for this kind of application in order to save costs.

Sensor Type: Switch

- HAL 15xy 3-wire

Buckle Switch

Due to the greater distance from the sensor to the control unit, a 2-wire Hall switch is often the preferred sensor type for buckle applications. Depending on the application set-up a unipolar or latching type can be used.

Sensor Type: Switch

- HAL 15xy 2-wire

Bending Lights

Within the Adaptive Headlights module, the "zero-position" of the swivel module is generally given by a Hall-effect switch. The HVC family also provides a fully integrated solution to drive the electric motors (stepper or BLDC) of the actuator

Sensor Type: Switch, 2D,

Controller Type: HVC

- HAL 1002
- HAL 15xy 3-wire
- HAL 37xy
- HVC 2480B
- HVC 4223F

HVAC

Micronas HVC solutions are offering ideal small and highly integrated one-chip-all-inclusive solutions allowing motor control with different driving schemes with low motor current ripple, supporting stall detection.

Sensor Type: Switch, Controller Type: HVC

- HAL 15xy 2-wire
- HVC 4223F

Blower and Flap Control, LED Fans

Typically used for LED headlights cooling and mist removal, LED fans require efficient actuators with very small footprint. HVC all-in-one integrated solutions are matching the power requirements for BLDC motor drive in a compact single-chip solution without the need for external MOSFETs.

Controller Type: HVC

- HVC 2480B
- HVC 4223F

Blower and Flap Control – AGM

The active grille shutter module provides an efficient reduction of emissions and allows fuel savings. Micronas highly integrated on-chip motor drive solutions enable higher torque at higher temperatures, smaller size and more sophisticated control.

Controller Type: HVC

- HVC 2480B
- HVC 4223F

Seat – Position

The seat position detection is one part of the airbag control system. The task of the Hall switch is to determine the zone along the seat track, where the seat is actually positioned. 2-wire switches are the preferred solution.

Sensor Type: Switch

- HAL 15xy 2-wire

Seat – Climate Control

HVC all-in-one integrated solutions are matching the power requirements for BLDC motor drive in a single-chip solution without the need for external MOSFETs and allow a distributed system of motor controllers within the seat by LIN network interconnection.

Controller Type: HVC

- HVC 2480B
- HVC 4223F

Industrial Applications

Micronas' sensor and embedded controller solutions are also sought after in non-automotive applications. They are widely used in all types of white goods, such as washing machines, tumble dryers, induction cookers, as well as heating and cooling systems. Further areas of applications can be found in the industrial arena, for example to control robots or to automate assembly equipment. Hall-effect sensors can be found in almost any machine that needs to measure position, linear or rotational movement or even current. By means of the Hall-effect other parameters can also be measured indirectly like rpm, leveling, pressure, force or even torque.



Building, Home and Office Automation

Micronas provides solutions for Building, Home and Office Automation from HVAC (Heating, Ventilation, and Air Conditioning), Rolling Shutters, Vending Machines to Printers and Metering applications.



Factory and Process Automation

Micronas provides solutions for Factory and Process Automation applications from Solar Energy, Man-Machine Interface to Process Control.



Home Appliance and White Goods

Micronas provides solutions for Home Appliances and White Goods from Washing Machine, Dishwasher, Cook Top to Coffee Machine.



Mobility and Robotics

Micronas aims to provide solutions for Mobility and Robotics from E-Bike, Wheel Chair, Mower to Robot.



Garden and Power Tools

Micronas aims to provide solutions for Garden and Power Tools from Mower, Chain Saw to Cordless Drill



Agricultural and Heavy Machinery

Micronas aims to provide solutions for Agricultural and Heavy Machinery from Harvester, Tractor Dozer, to Excavator.

Overview of Major Product Families

Hall Switches

Single Hall Plate

HAL 1xy

- 3-wire output
- Different switching points
- $T_J = -20$ to 125 °C
- TO92 or SOT89 package

HAL 2xy

- Open-drain output
- Chopper stabilized
- Different switching points
- $T_J = -40$ to 140 °C
- TO92 or SOT89 package

HAL 5xy

- 3-wire- and 2-wire open-drain output
- Chopper stabilized
- High-precision thresholds
- Different switching points
- $T_J = -40$ to 170 °C
- TO92 or SOT89 package

HAL 1002

- 3-wire push-pull output
- Chopper stabilized
- High-precision thresholds
- Programmable switching points and behavior
- $T_J = -40$ to 170 °C
- TO92 or SOT89 package

HAL 15xy

- 3-wire open-drain output or 2-wire current output
- Chopper stabilized
- High-precision thresholds
- Different switching points and behavior
- $T_J = -40$ to 170 °C
- SOT23 package

Dual Hall Plate

HAL 3x0

- Open-drain output
- Zero speed differential sensor
- Chopper stabilized
- $T_J = -40$ to 170 °C
- TO92 or SOT89 package

HAL 7xy

- Open-drain output
- Speed and direction signal
- Chopper stabilized
- Different switching points
- $T_J = -40$ to 140 °C
- SOT89 package

Linear Distance Sensors

HAL 4xy

- $T_J = -40$ to 170 °C
- SOT89 package

HAL 8xy

- $T_J = -40$ to 170 °C
- TO92 or SOIC8 package
- Programmable (EEPROM)

HAL 18xy

- $T_J = -40$ to 170 °C
- TO92 or SOT89 package
- Ratiometric analog output (10 bit)

HAL 4x1

- Differential output
- Magnetic flux range: -50 to $+50$ mT
- Chopper stabilized

HAL 81x/82x/83x

- Different linear output formats (analog, PWM)
- High accuracy

HAC 830

- Analog output
- Temperature stability
- Integrated capacitors
- TO92-UP package

HAL 85x

- 32 setpoints linearization
- PWM and serial output
- 12 V battery connection

HAL 880

- Analog output
- Limited temperature range

HAL 1820

- Programmable (EEPROM)

HAL 1821/22/23

- Pre-configured sensitivity

HAL 24xy

- $T_J = -40$ to 170 °C
- TO92 or SOIC8 package
- Programmable (EEPROM)
- High-precision sensors
- Extended distance measurement
- Internal diagnostics

HAL 28xy

- $T_J = -40$ to 170 °C
- TO92 package
- Programmable (EEPROM)
- High-precision sensors
- Digital output
- Direct battery connection

HAL 2420

- 2-point calibration

HAL 2425

- 2-point calibration
- 16 setpoints linearization

HAR 2425

- Dual-die version in TSSOP14

HAL 2455

- PWM output (up to 2 kHz)
- 16 setpoints linearization

HAR 2455

- Dual-die version in TSSOP14

HAL 283x

- SENT interface
- Up to 16-bit resolution

HAL 2850

- PWM output
- 12-bit resolution

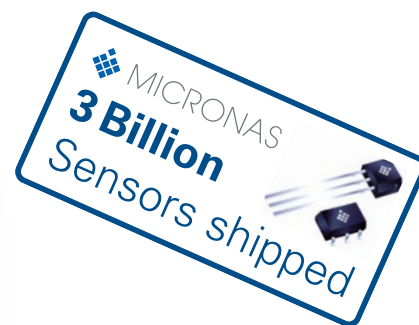

Direct-Angle Sensors (Linear and Angular Position)

HAL 36xy/38xy

- $T_J = -40$ to 170 °C
- SOIC8 package
- High accuracy
- Programmable characteristics in a non-volatile memory
- Diagnostic functions
- 32 setpoint linearization

HAL 3625

- 12-bit ratiometric analog output
- Measurement of rotating angles up to 360°

HAL 3675

- PWM output, 250 Hz to 2 kHz
- Measurement of rotating angles up to 360°

HAL 385x

- 12-bit analog output
- Position and off-axis rotation

HAL 387x

- PWM output, 250 Hz to 2 kHz
- Position and off-axis rotation

HAL 37xy

- $T_J = -40$ to 170 °C
- SOIC8 or TO92UP package
- Superior accuracy
- Programmable characteristics in a non-volatile memory
- Diagnostic functions
- Measurement of angular and linear position

HAL 371x

- 12-bit analog modulo output

HAL 372x

- 12-bit analog output

HAL 373x

- PWM and SENT output

Current Sensors

CUR 310x

- $T_J = -40$ to 170 °C
- TO92 or SOIC8 package

CUR 3105

- Ratiometric output
- High-precision current transducer
- Digital signal processing

CUR 311x

- $T_J = -40$ to 170 °C
- SOIC8 package

CUR 3115

- Ratiometric output
- High-precision current transducer
- Digital signal processing
- Short distance between conducting medium and sensitive area

Gas Sensors

GAS 86xyB

- $T_J = -40$ to 85 °C
- QFN20 open cavity package
- 2 independent gas sensing devices
- Target gases: H_2 , NO_2 , NH_3 , and VOC
- Integrated temperature and relative humidity sensor
- Digital SPI interface

GAS 8616B

- Target gases: $H_2 + NO_2$

GAS 8645B

- Target gases: $NH_3 + VOC$

Embedded Motor Controllers for Smart Actuators

HVC 2480B

- $T_J = -40$ to 140 °C
- QFN40 package, 6x8 mm

HVC 2480B

- Supply voltage: 5.4 V to 18 V
- Internal Half-Bridges for direct drive of DC motors up to 3×300 mA

HVC 4223F

- $T_J = -40$ to 150 °C
- QFN40 package, 6x6 mm

HVC 4223F

- Dual Mode Supply Voltage: 5.4 V to 18 V, 40 V load dump
- Internal Half-Bridges with charge pump up to 3×600 mA

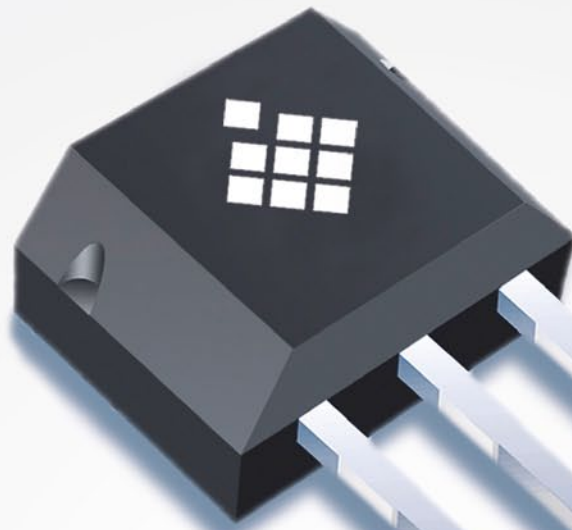

Hall Switches for Position Detection

Hall switches are commonly used for end-position detection. The sensor recognizes the presence of a magnetic field by signalling an ON/OFF state. Therefore, Hall switches are widely used to replace micro switches, offering superior quality and durability performance.



Linear Hall Sensors for Linear Movement

Linear sensors are used to obtain a signal proportional to a linear movement or an electric current level being measured. The output signals can be analog or in digital formats. Due to these proven advantages Hall-effect sensors are widely used to replace conventional potentiometers.



Direct-Angle Sensors for Precise Angular Measurements

Direct-angle sensors measure the sine and cosine components of a magnetic field. This is possible due to the new 3D HAL[®] technology from Micronas which employs vertical Hall plates to detect the magnetic field components in the chip plane. These kind of sensors provide angular and position information directly via an output signal proportional to the measured angle or position.

Introduction to Hall-effect Technology

Owing to their various advantages like contactless sensing and high reliability, Hall-effect sensors are indispensable components in the Automotive and Industrial sector. Silicon is used almost exclusively as a basic material for the technical implementation of magnetic field sensors, as the Hall-effect is most pronounced in semiconductors. For these achievements we rely on an US American physicist, named Edwin Herbert Hall (1855–1938) after whom this physical effect is named. He found out that the electrons of the current flow in an electrical conductor are diverted from their normal direct path by an outer magnetic field applied perpendicular to their motion. Due to the so-called Lorentz force, a potential difference is created proportional to the field strength of the magnetic field and to the current strength. Based on this effect, Hall sensors can detect various parameters.

RPM Measurement

When applying a magnet to a propeller or tooth wheel, the Hall-effect sensor (typically a Hall switch) detects the change of the magnetic field (ON/OFF state) and counts these changes.

Rotary Position

Typically, linear and direct-angle Hall sensors are used in applications where a rotary position has to be continuously measured. Both sensor types output a signal which is proportional to the angular positions. Linear Hall sensors are often used for smaller angular ranges whereas a direct-angle sensor is well suited for angles up to 360°.

Leveling

The measurement of a liquid level is carried out via detection of either a rotary position (when a float gauge module is used) or a linear movement.

Force/Pressure Measurement

The Hall-effect sensor detects the displacement of a spring or a membrane when applying force or pressure to it. The displacement is nothing but a linear movement.

Torque Measurement

Torque measurement represents a sub-form of force measurement. When a force or torque is applied, the displacement of one object or two objects adjacent to each other can be measured by a linear Hall sensor.

Selection Guide

Hall-Effect Sensors

Guide Linear Distance Sensors

Guide Hall Switches

Guide Current Sensors

Functions

- Position Detection
- Linear Movement
- Current Measurement

Generic Applications

- RPM Measurement
- Rotary Position
- Leveling
- Force/Pressure Measurement
- Torque Measurement



PRESSURE



HUMIDITY



GAS



POSITION



CURRENT



TEMPERATURE



DISTANCE



ANGLE



STEPPER



EMBEDDED CONTROLLER



TORQUE



BDC

Selection Guide

Additional Information

Unipolar:	Output turns low with magnetic south pole and turns high when the magnetic field is removed. Sensor does not respond to magnetic north pole of magnet.
Latching:	Output turns low with the magnetic south pole and turns high with the magnetic north pole of the magnet. The output does not change if the magnetic field is removed.
Bipolar:	Output turns low with magnetic south pole and turns high with the magnetic north pole. The output state is not defined if the magnetic field is removed.
Unipolar Inverted	Output turns high with magnetic south pole and turns low if the magnetic field is removed.

L = Low Sensitivity

M = Medium Sensitivity

H = High Sensitivity

1 Power-on reset and undervoltage reset

2 Undervoltage reset

3 North pole sensitive

4 Integrated capacitors

5 Dual-die version

6 "Die down" package

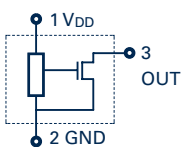

3-Wire Switch:

The voltage is monitored and the switch operates as indicated according to the type of switch.

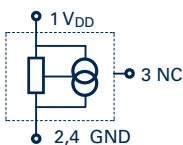

2-Wire Switch:

The current is monitored and the switch operates as indicated by the type of switch. Current level is as specified within the data sheet.

Hardware/Software Information

Programming Information	HAL APB (HAL 81x, HAL 82x, HAL 83x, HAL 85x, HAL 880, HAL 100x, CUR 31xy)	HAL APB (HAL 18xy, HAL 24xy, HAL 28xy, HAL 36xy, HAL 37xy, HAL 38xy)	HAL USB-Kit (HAL 18xy, HAL 24xy, HAL 36xy, HAL 37xy, HAL 38xy)
Hardware version:	V5.10	V1.5	V1.01
Firmware version:	V1.32	V2.32	V9.07

Package Information

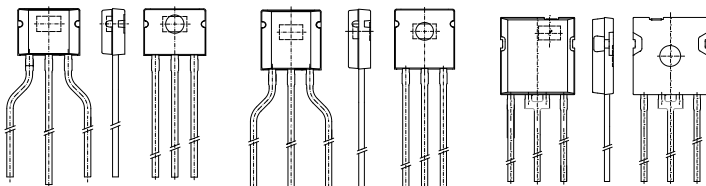

TO92UA

TO92UT

TO92UP 3-pin

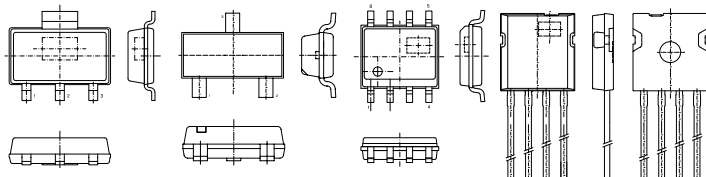

SOT89B

SOT23

SOIC8

TO92UP 4-pin

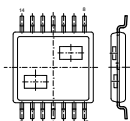

TSSOP14

Switches

Part Type	Magnetic Characteristics Typical @ 25 °C		Type					Configuration			Pkg			Temperature Range					Application Range								
	B_{ON} - [mT]	B_{OFF} - [mT]	Unipolar	Unipolar Inverted	Bipolar	Latching	Differential	2-Wire	3-Wire	4-Wire	TO92	SOT23	SOT89	C: $T_J = 0\text{ °C}$ to 85 °C	I: $T_J = -20\text{ °C}$ to 125 °C	E: $T_J = -40\text{ °C}$ to 100 °C	K: $T_J = -40\text{ °C}$ to 140 °C	A: $T_J = -40\text{ °C}$ to 170 °C	Function: Pos. and End-Point	Application: Solid State Switch	Examples:						
																					Direction Detection	RPM Measurement	Brushless DC Motor	Rotating Speed	Ignition Timing	Window Lifter	
HAL 1xy	HAL 101	34.0	24.0	L																							
	HAL 102	2.6	-2.6				H																				
	HAL 103	7.6	-7.6				M																				
	HAL 104	14.0	-14.0				L																				
	HAL 106	12.0	6.5	H																							
	HAL 107	26.5	22.5	L																							
	HAL 108	17.0	15.0	M																							
	HAL 109	7.9	5.7	H																							
	HAL 2xy	HAL 201	34.0	24.0	L																						
HAL 202		2.6	-2.6				H																				
HAL 203		7.6	-7.6				M																				
HAL 204		14.0	-14.0				L																				
HAL 206		12.0	6.5	H																							
HAL 207		26.5	22.5	L																							
HAL 208		17.0	15.0	M																							
HAL 210		7.9	5.7	H																							
HAL 211		-5.2	-7.6		H																						
HAL 212		28.9	27.1	L																							
HAL 220 ¹		2.6	-2.6				H																				
HAL 221 ¹		18.5	12	L																							
HAL 3xy	HAL 300	1.2	-1.0				H																				
	HAL 320	3.5	-3.5				H																				
HAL 5xy	HAL 501	0.5	-0.7			H																					
	HAL 502	2.6	-2.6				H																				
	HAL 503	8.0	-8.0				M																				
	HAL 504	12.0	7.0	M																							
	HAL 505	13.5	-13.5				L																				
	HAL 506	5.5	3.5	H																							
	HAL 508	18.0	16	M																							
	HAL 509	26.8	23.2	L																							
	HAL 516	3.5	5.5		H																						
	HAL 519 ³	-3.6	-5.5		H																						
	HAL 523	34.5	24	L																							
	HAL 526	14.0	-14.0				L																				
	HAL 542 ¹	2.6	-2.6				H																				
	HAL 543 ¹	27.0	21.0	L																							
	HAL 546 ¹	5.5	3.5	H																							
	HAL 548	18.0	12.0	M																							
	HAL 549 ^{2,3}	-5.5	-3.6	H																							
	HAL 556	6.0	3.8	H																							
	HAL 566	3.9	5.9		H																						
	HAL 573	43.5	41.5	L																							
	HAL 574	9.2	7.2	M																							
	HAL 575	4.0	-4.0				M																				
	HAL 576	5.7	4.2	M																							
	HAL 579	12.0	-12.0				M																				
	HAL 581	10.0	12.0		M																						
	HAL 584	7.2	9.2		M																						
	HAL 7xy	HAL 700	14.9	-14.9				M																			
		HAL 702	1.8	-1.8				H																			
HAL 730		14.9	-14.9				M																				
HAL 740		11.5	12.5	M																							
HAL 10xy	HAL 1002	Programmable																									
HAL 15xy	HAL 1501	0.5	-0.5			H																					
	HAL 1502	2.5	-2.5				H																				
	HAL 1503	5.5	3.5	M																							
	HAL 1506	18	16	L																							
	HAL 1507	27	23	L																							
	HAL 1508	-5.5	-3.5	M																							
	HAL 1509	3.5	5.5		M																						
	HAL 1562	12	-12				L																				
	HAL 1563	7	9		M																						
	HAL 1564	4	6		M																						
	HAL 1565	6	4	M																							
	HAL 1566	9	7	M																							

Linear Distance Sensors

Part Type	Magnetic Range		Type					Configuration					Electrical Characteristics		Config.			Pkg			Temperature Range					Application Range																
	Programmable	B _{min} [mT]	B _{max} [mT]	Setpoints	Analog	PWM	Serial	Differential	SENT	Overvoltage Detection	Undervoltage Detection	Open VDD Detection	Open GND Detection	Overcurrent Detection	VDD [V]	I _{out} (max) - [mA]	2-Wire	3-Wire	4-Wire	TO92	SOT89	SOIC8	TSSOP14	C: T _J = 0 °C to 85 °C	I: T _J = -20 °C to 125 °C	E: T _J = -40 °C to 100 °C	K: T _J = -40 °C to 140 °C	A: T _J = -40 °C to 170 °C	Function	Generic Application												
HAL 4x1	HAL 401	-50	50	0	•				•					4.8 to 12	1			•		•							•	•	•	•												
	HAL 411	-50	50	0	•			•	•					4.9 to 5.1	1			•		•						•	•	•	•	•	•	•	•									
HAL 8xy	HAL 810	• ±30	±150	2		▲					•	•		4.5 to 5.5	1		•		•							•	•	•	•	•	•	•	•	•								
	HAL 817	• ±30	±150	2	•					•	•	•	•	4.5 to 5.5	1		•		•							•	•	•	•	•	•	•	•	•	•							
	HAL 825	• ±30	±100	2	•					•	•	•	•	4.5 to 5.5	1		•		•							•	•	•	•	•	•	•	•	•	•	•						
	HAL 830	• ±30	±100	2	•					•	•	•	•	4.5 to 5.5	1.2		•		•							•	•	•	•	•	•	•	•	•	•	•	•					
	HAC 830 ⁴	• ±30	±100	2	•					•	•	•	•	4.5 to 5.5	1.2		•		•							•	•	•	•	•	•	•	•	•	•	•	•					
	HAL 835	• ±15	±150	2	•	■				•	•	•	•	4.5 to 5.5	1.2		•		•							•	•	•	•	•	•	•	•	•	•	•	•					
	HAL 855	• ±30	±150	32		■	•				•	•	•	4.5 to 14	20		•		•							•	•	•	•	•	•	•	•	•	•	•	•	•				
	HAL 856	• ±30	±150	32		■	•				•	•	•	4.5 to 14	◆	•			•							•	•	•	•	•	•	•	•	•	•	•	•	•				
	HAL 880	• ±30	±100	2	•					•	•	•	•	4.5 to 5.5	1		•		•							•	•	•	•	•	•	•	•	•	•	•	•	•				
HAL 18xy	HAL 1820	• ±20	±160	2	•				•	•		•	4.5 to 5.5	1		•		•	•						•	•	•	•	•	•	•	•	•	•	•	•	•					
	HAL 1821	-50	+50	0	•				•	•		•	4.5 to 5.5	1		•		•	•						•	•	•	•	•	•	•	•	•	•	•	•	•	•				
	HAL 1822	-80	+80	0	•				•	•		•	4.5 to 5.5	1		•		•	•						•	•	•	•	•	•	•	•	•	•	•	•	•	•	•			
	HAL 1823	-100	+100	0	•				•	•		•	4.5 to 5.5	1		•		•	•						•	•	•	•	•	•	•	•	•	•	•	•	•	•	•			
HAL 24xy	HAL 2420	• ±25	±200	2	•				•	•	•	•	4.5 to 5.5	1.2		•		•	•						•	•	•	•	•	•	•	•	•	•	•	•	•	•	•			
	HAL 2425	• ±25	±200	16	•				•	•	•	•	4.5 to 5.5	1.2		•		•	•						•	•	•	•	•	•	•	•	•	•	•	•	•	•	•	•		
	HAR 2425 ⁵	• ±25	±200	16	•				•	•	•	•	4.5 to 5.5	1.2		•		•	•			•			•	•	•	•	•	•	•	•	•	•	•	•	•	•	•	•		
	HAL 2455	• ±25	±200	16		•			•	•	•	•	4.5 to 5.5	1.2		•		•	•						•	•	•	•	•	•	•	•	•	•	•	•	•	•	•	•		
	HAR 2455 ⁵	• ±25	±200	16		•			•	•	•	•	4.5 to 5.5	1.2		•		•	•			•			•	•	•	•	•	•	•	•	•	•	•	•	•	•	•	•		
HAL 28xy	HAL 2830	• ±20	±160	2					•	•	•	•	4.5 to 17	20		•		•	•						•	•	•	•	•	•	•	•	•	•	•	•	•	•	•	•		
	HAL 2831	• ±20	±160	2					•	•	•	•	4.5 to 17	20		•		•	•						•	•	•	•	•	•	•	•	•	•	•	•	•	•	•	•		
	HAL 2832	• ±20	±160	2					•	•	•	•	4.5 to 17	20		•		•	•						•	•	•	•	•	•	•	•	•	•	•	•	•	•	•	•	•	
	HAL 2833	• ±20	±160	2					•	•	•	•	4.5 to 17	20		•		•	•						•	•	•	•	•	•	•	•	•	•	•	•	•	•	•	•	•	
	HAL 2850	• ±20	±160	2		■			•	•	•	•	4.5 to 17	20		•		•	•						•	•	•	•	•	•	•	•	•	•	•	•	•	•	•	•	•	

▲ Fixed PWM frequency ■ Programmable PWM frequency ◆ Programmable: see data sheet

Direct-Angle Sensors

HAL 36xy	HAL 3625	• ±30	±100	32	•				•	•	•	•	4.5 to 5.5	1.2		•			•						•	•	•	•	•	•	•	•	•	•	•	•	•	•	•				
	HAL 3675	• ±30	±100	32		■			•	•	•	•	4.5 to 5.5	1.2		•			•						•	•	•	•	•	•	•	•	•	•	•	•	•	•	•	•			
HAL 37xy	HAL 3715	• ±20	±100	33	•				•	•	•	•	4.5 to 5.5	1.2		•		•	•						•	•	•	•	•	•	•	•	•	•	•	•	•	•	•	•	•		
	HAL 3725	• ±20	±100	33	•				•	•	•	•	4.5 to 5.5	1.2		•		•	•						•	•	•	•	•	•	•	•	•	•	•	•	•	•	•	•	•		
	HAL 3726	• ±20	±100	33	•				•	•	•	•	4.5 to 5.5	1.2		•		•	•						•	•	•	•	•	•	•	•	•	•	•	•	•	•	•	•	•	•	
	HAL 3727	• ±20	±100	33	•				•	•	•	•	4.5 to 5.5	1.2		•		•	•						•	•	•	•	•	•	•	•	•	•	•	•	•	•	•	•	•	•	
	HAL 3735	• ±20	±100	33	•	■			•	•	•	•	4.5 to 5.5	1.2		•		•	•						•	•	•	•	•	•	•	•	•	•	•	•	•	•	•	•	•	•	
	HAL 3736	• ±20	±100	33	•	■			•	•	•	•	4.5 to 5.5	1.2		•		•	•						•	•	•	•	•	•	•	•	•	•	•	•	•	•	•	•	•	•	
	HAL 3737	• ±20	±100	33	•	■			•	•	•	•	4.5 to 5.5	1.2		•		•	•						•	•	•	•	•	•	•	•	•	•	•	•	•	•	•	•	•	•	
HAL 38xy	HAL 385x	• ±30	±55	32	•				•	•	•	•	4.5 to 5.5	1		•			•					•	•	•	•	•	•	•	•	•	•	•	•	•	•	•	•	•	•		
	HAL 387x	• ±30	±55	32		■			•	•	•	•	4.5 to 5.5	1		•			•					•	•	•	•	•	•	•	•	•	•	•	•	•	•	•	•	•	•		

■ Programmable PWM frequency

Current Sensors

CUR 311x	CUR 3105	• ±30	±100	2	•				•	•	•	•	4.5 to 5.5	1.2		•			•					•	•	•	•	•	•	•	•	•	•	•	•	•	•	•	•	•		
	CUR 3115 ⁶	• ±30	±100	2	•				•	•	•	•	4.5 to 5.5	1.2		•			•					•	•	•	•	•	•	•	•	•	•	•	•	•	•	•	•	•	•	•

Hall Ordering Codes

HAL	502	PA	T	C	P	Q	SP
Hall Sensor	Sensor Type	Package UA/JQ = TO92UA UT = TO92UT UP = TO92UP SF/TQ = SOT89B SU = SOT23 DJ = SOIC8 DZ = SOIC8 "Die down" GP = TSSOP14	Temperature Range C: T _J = 0 °C to 85 °C I: T _J = -20 °C to 125 °C E: T _J = -40 °C to 100 °C K: T _J = -40 °C to 140 °C A: T _J = -40 °C to 170 °C	Configuration 1 = TO92 – Inline, Spread (Ammopack only) 2 = TO92 – Inline, Not Spread 4 = SOT89 – Carrier Tape 4 = SOT23 – Carrier Tape 4 = SOIC8 – Carrier Tape	Packaging B = Bulk A = Ammpack R = Reel (SOT89, SOT23, and SOIC8)	Quantity 1 = 2000 per box 2 = 2000 per box 5 = 15000 per box 8 = 7000 per box	Special Procedure

HAL 1xy

Hall Switch Family designed for White Goods and Industrial Applications

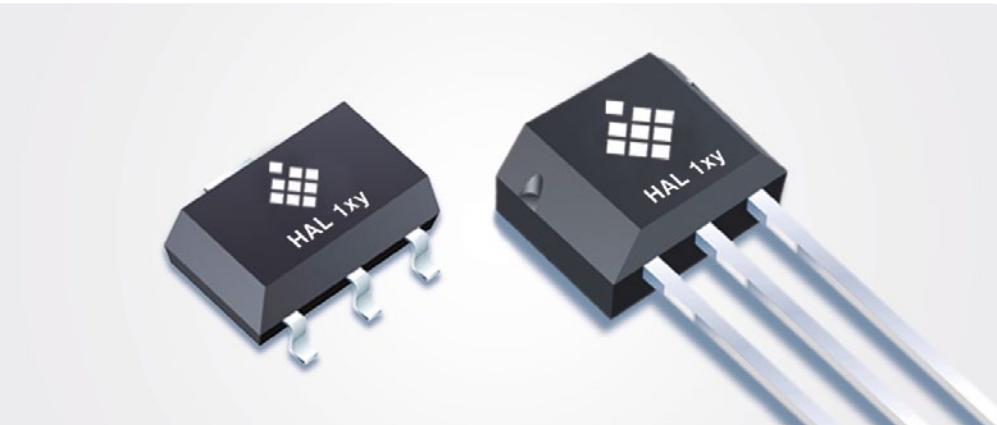

The HAL 1xy family represents easy-to-use Hall switches for white goods and industrial applications. It is the optimal system solution to detect a position by means of contactless measurement. In motor applications, the Hall sensor family is often used to derive an RPM measurement.

Technically, the sensors are produced in CMOS technology and include a temperature-compensated Hall plate with active offset compensation, a comparator, and an open-drain output transistor.

The comparator compares the actual magnetic flux through the Hall plate (Hall voltage) with the fixed reference values (switching points). Accordingly, the output transistor is switched on or off.

The active offset compensation leads to magnetic parameters which are robust against mechanical stress effects. In addition, the magnetic characteristics are constant in the full supply voltage and temperature range.

The HAL 1xy family is available in the SOT89B SMD package and in the leaded TO92UA package.

Features

- Temperature ranges:
 - C (Commercial, $T_J = 0\text{ }^\circ\text{C}$ to $85\text{ }^\circ\text{C}$)
 - I (Industrial, $T_J = -20\text{ }^\circ\text{C}$ to $125\text{ }^\circ\text{C}$)
- Operates from 3.8 V to 24 V supply voltage
- Operates with static magnetic fields and dynamic magnetic fields up to 10 kHz
- Overvoltage protection at all pins
- Reverse-voltage protection at VDD pin
- Magnetic characteristics are robust against mechanical stress effects
- Short-circuit protected open-drain output by thermal shutdown
- Constant switching points over a wide supply voltage and temperature range
- The decrease of magnetic flux density caused by rising temperature in the sensor system is compensated by a built-in negative temperature coefficient of the magnetic characteristics
- High temperature stability for home appliances and industrial applications
- High ESD performance: 8 kV

Functions

The HAL 1xy is the optimal system solution for application fields, such as:

- Position detection

Generic Applications

- RPM measurement

Application Examples

- Motor commutation
- Selector switches
- Speed control
- Flow meter

HAL 2xy

Hall-Effect Sensor Family

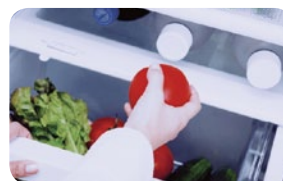
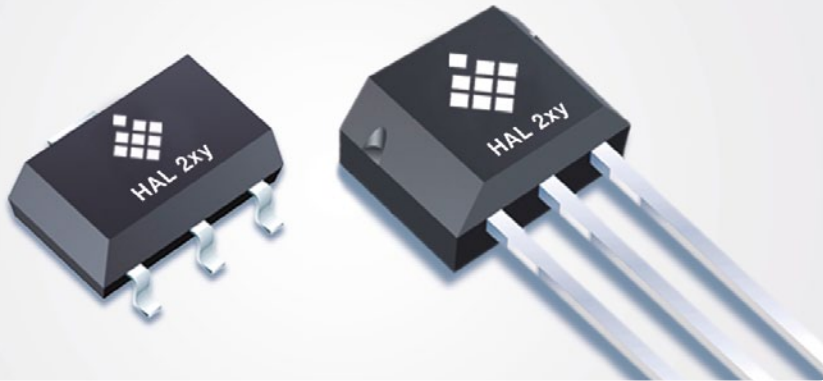

The HAL 2xy Hall switch family is fully compatible to the HAL 1xy family, adding the general use for automotive in-cabin applications by expanding the temperature range to a level of $T_J = -40\text{ °C}$ up to 140 °C .

Like the HAL 1xy, the HAL 2xy Hall switch family is produced in CMOS technology. The sensors include a temperature-compensated Hall plate with active offset compensation, a comparator, and an open-drain output transistor.

The comparator compares the actual magnetic flux through the Hall plate (Hall voltage) with the fixed reference values (switching points). Accordingly, the output transistor is switched on or off.

The active offset compensation leads to magnetic parameters, which are robust against mechanical stress effects. In addition, the magnetic characteristics are constant in the full supply voltage and temperature range.

The sensors are designed for automotive and industrial applications and operate with supply voltages from 3.8 V to 24 V in the junction temperature range from -40 °C up to 140 °C .

The HAL 2xy family is dedicated to automotive and industrial applications available in the SMD package SOT89B and in the leaded version TO92UA.

Features

- Temperature range K:
 $T_J = -40\text{ °C}$ to 140 °C
- Operates from 3.8 V to 24 V supply voltage
- Operates with static magnetic fields and dynamic magnetic fields up to 10 kHz
- Overvoltage protection at all pins
- Reverse voltage protection at VDD pin
- Magnetic characteristics are robust against mechanical stress effects
- Short-circuit protected open-drain output by thermal shutdown
- Constant switching points over a wide supply voltage and temperature range
- The decrease of magnetic flux density caused by rising temperature in the sensor system is compensated by a built-in negative temperature coefficient of the magnetic characteristics
- High temperature stability for automotive or industrial applications
- High ESD performance: 8 kV

Functions

The HAL 2xy is the optimal system solution for applications such as:

- Position detection

Generic Applications

- RPM measurement

Application Examples

- Motor commutation
- Anti-squeeze protection (power-window)
- Speed control
- Flow meter
- Gear selector

HAL 300, HAL 320

Differential Hall-Effect Sensor ICs

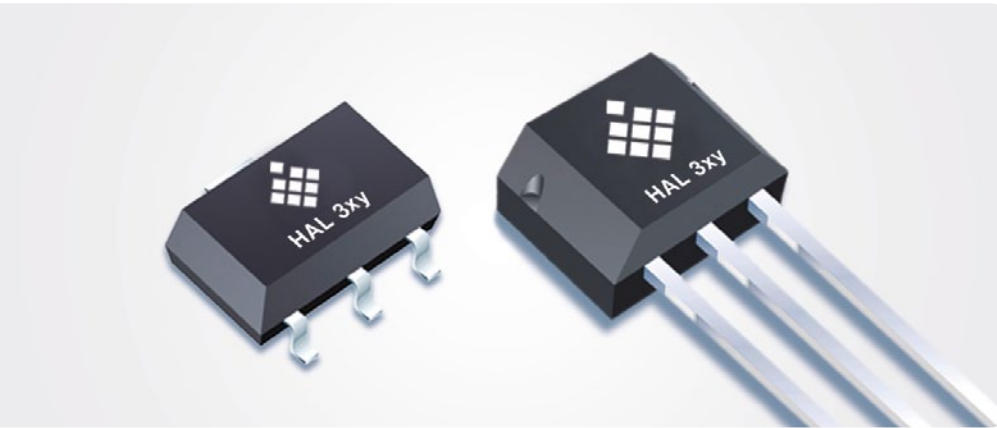

The HAL 300 and the HAL 320 are differential Hall switches produced in CMOS technology. The sensors include two temperature-compensated Hall plates with active offset compensation, a differential amplifier with a Schmitt trigger, and an open-drain output transistor.

These differential sensors respond to spatial differences of the magnetic field. The Hall voltages at the two Hall plates, S1 and S2, are amplified with a differential amplifier. The differential signal is compared with the actual switching level of the internal Schmitt trigger. Accordingly, the output transistor is switched on or off. The differential signal can be derived via a rotating multi-pole-ring in front of the branded side of the package (HAL 300) or via a magnet on the back side of the package generating a back-bias field at both Hall plates (HAL 320).

The active offset compensation leads to constant magnetic characteristics over supply voltage and temperature. The sensors are designed for automotive and industrial applications and operate with supply voltages from 4.5 to 24 V in the junction temperature range $-40\text{ }^{\circ}\text{C}$ up to $170\text{ }^{\circ}\text{C}$.

The sensors are available in the SMD package SOT89B and in the leaded version TO92UA.

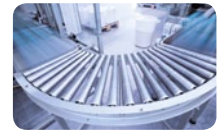

Features

- Temperature range K:
 $T_J = -40\text{ }^{\circ}\text{C}$ to $170\text{ }^{\circ}\text{C}$
- Operates from 4.5 V to 24 V supply voltage
- Operates with static magnetic fields and dynamic magnetic fields up to 10 kHz
- Overvoltage protection at all pins
- Reverse voltage protection at VDD pin
- Magnetic characteristics are robust against mechanical stress effects
- Short-circuit protected open-drain output by thermal shut down
- Constant switching points over a wide supply voltage and temperature range
- The decrease of magnetic flux density caused by rising temperature in the sensor system is compensated by a built-in negative temperature coefficient of the magnetic characteristics
- High temperature stability for automotive or industrial applications
- High ESD performance: 8 kV

Functions

The HAL 300 and HAL 320 are the optimal system solutions for applications such as:

- Position detection

Generic Applications

- RPM Management

Application Examples

- Speed Control
- Flow meter

HAL 5xy

High-Performance Hall-Effect Sensor Family



The HAL 5xy family complements Micronas' Hall sensor portfolio towards the higher end by offering an extended automotive temperature range of $T_j = -40\text{ °C}$ to 170 °C . The HAL 5xy family consists of different Hall switches produced in CMOS technology. All sensors include a temperature-compensated Hall plate with active offset compensation and a comparator.

Depending on the family member, the switching state is output via an open-drain transistor or by altering the supply current level (two-wire Hall-effect sensor).

The comparator compares the actual magnetic flux through the Hall plate (Hall voltage) with the fixed reference values (switching points). Accordingly, the output transistor is switched on or off.

The sensors of this family differ in the switching behavior and the switching points. The active offset compensation leads to constant magnetic characteristics over supply voltage and temperature range. In addition, the magnetic parameters are robust against mechanical stress effects.

The sensors of the HAL 5xy family are designed for automotive and industrial applications and operate with supply voltages from 3.8V to 24V in the junction temperature range from -40 °C up to 170 °C .

All sensors are available in the SMD package SOT89B and in the leaded version TO92UA.

Features

- Operates from -40 °C up to 170 °C junction temperature
- Two- and three-wire versions
- Operates from 3.8V to 24V supply voltage
- Overvoltage protection at all pins
- Reverse voltage protection at VDD pin
- Magnetic characteristics are robust regarding mechanical stress effects
- Short-circuit protected open-drain output by thermal shut down or current output for two-wire applications
- Operates with static magnetic fields and dynamic magnetic fields up to 10 kHz
- Constant switching points over a wide supply voltage range
- The decrease of magnetic flux density caused by rising temperature in the sensor system is compensated by a built-in negative temperature coefficient of the magnetic characteristics
- Ideal sensor for applications in extreme automotive and industrial environments
- EMC corresponding to ISO 7637
- High ESD performance: 8 kV

Functions

The HAL 5xy is the optimal system solutions for applications such as:

- Position detection

Generic Applications

- RPM measurement
- Powertrain

Application Examples

- Motor commutation
- Anti-squeeze protection (power-window)
- Speed control
- Buckle-switch
- Gear selector
- Steering lock

HAL 7xy

Dual Hall-Effect Sensors with two Independent Outputs



HAL 7xy is a family of monolithic integrated Hall-effect sensors manufactured in CMOS technology with two independent Hall plates S1 and S2. Both devices have two open-drain outputs.

The sensor HAL 730 is particularly featuring a count and a direction output. The count output operates like a single latched Hall switch according to the magnetic field present at Hall plate S1. The direction output indicates the direction of a linear or rotating movement of magnetic objects.

In combination with an active target providing a sequence of alternating magnetic north and south poles, the sensors generate the signals required to control position, speed, and direction of the target movement.

The HAL 7xy sensors include temperature compensation and active offset compensation. These features provide excellent stability and matching of the switching points in the presence of mechanical stress over the whole temperature and supply voltage range.

The HAL 7xy family is designed for automotive and industrial applications and operate with supply voltages from 3.8 V to 24 V in the junction temperature range from $-40\text{ }^{\circ}\text{C}$ up to $170\text{ }^{\circ}\text{C}$. The sensors are available in the SMD package SOT89B.

Features

- Operates from $-40\text{ }^{\circ}\text{C}$ up to $170\text{ }^{\circ}\text{C}$ junction temperature
- Operates from 3.8 V to 24 V supply voltage
- Generation of a direction signal (HAL 730 only)
- Operates with static magnetic fields and dynamic magnetic fields up to 10 kHz
- Overvoltage protection at all pins
- Reverse-voltage protection at VDD pin
- Magnetic characteristics are robust against mechanical stress effects
- Short-circuit protected open-drain outputs by thermal shut down
- Constant switching points over a wide supply voltage and temperature range
- The decrease of magnetic flux density caused by rising temperature in the sensor system is compensated by a built-in negative temperature coefficient of the magnetic characteristics
- High temperature stability for automotive or industrial applications
- High ESD performance: 8 kV

Functions

The HAL 7xy is the optimal system solution for applications, such as:

- Position and direction detection

Application Examples

- End position detection
- Liquid-level detection
- Electronic fuse

HAL 1002

In-System Programmable Hall Switches

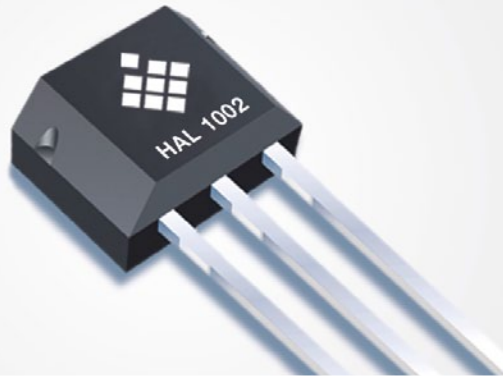

The HAL 1002 is the improved successor of the HAL 1000 Hall switch. The major sensor characteristics, the two switching points B_{ON} and B_{OFF} , are programmable for the application. The sensor can be programmed to be unipolar or latching, sensitive to the magnetic north pole or sensitive to the south pole, with normal or with an electrically inverted output signal.

The HAL 1002 features a temperature-compensated Hall plate with chopper offset compensation, an A/D converter, digital signal processing, a push-pull output stage, an EEPROM memory with redundancy and lock function for the calibration data, a serial interface for programming the EEPROM, and protection devices at all pins.

The HAL 1002 is programmable by modulating the supply voltage. Programming is simplified through the use of a 2-point calibration. The tolerances of the sensor, the magnet, and the mechanical positioning can be compensated for the final assembly. The temperature compensation of the Hall IC can be tailored to all common magnetic materials. This enables operation over the full temperature range with constant switching points.

The calculation of the individual sensor characteristics and the programming of the EEPROM memory can easily be done with a PC and the application kit from Micronas.

The sensor is designed for the use in hostile industrial and automotive applications in the ambient temperature range from $-40\text{ }^{\circ}\text{C}$ up to $150\text{ }^{\circ}\text{C}$.

The HAL 1002 is available in the leaded package TO92UT-2.

Features

- Operates from $-40\text{ }^{\circ}\text{C}$ up to $170\text{ }^{\circ}\text{C}$ junction temperature
- High-precision Hall switch with programmable switching points and switching behavior
- Switching points programmable from -30 mT up to 150 mT in steps of 0.5% of the magnetic field range
- Multiple programmable magnetic characteristics in a non-volatile memory (EEPROM) with redundancy and lock function
- Temperature characteristics are programmable for matching all common magnetic materials
- Programming through modulation of the supply voltage
- Operates from 4.5 V up to 5.5 V supply voltage in specification and functions up to 8.5 V
- Operates with static magnetic fields and dynamic magnetic fields up to 2 kHz
- Magnetic characteristics are extremely robust against mechanical stress effects
- Overvoltage and reverse-voltage protection at all pins
- Short-circuit protected push-pull output
- High ESD performance: 8 kV
- EMC optimized design

Functions

The HAL 1002 is the optimal system solution for applications, such as:

- Position detection
- Current measurement

Application Examples

- End position detection
- Liquid-level detection
- Electronic fuse

HAL 15xy

First ISO 26262 Compliant, Low-Power Hall Switch in SOT23 Package



Features

- Sampling and output refresh time of 2 μ s
- 3-wire version with a short-circuit protected open-drain output
- 2-wire version with current output
- Very low current consumptions of typ. 1.6 mA and max. 2 mA (3-wire)
- Wide supply voltage operation from 2.7 V to 24 V
- Overvoltage protection capability up to 40 V
- Available in the smallest SOT23 package
- Highest ESD performance up to ± 8 kV
- Reverse-voltage protection at supply pin
- Operating with static and dynamic magnetic fields up to 12 kHz at lowest output jitter of max. 0.72 μ s (RMS). Customized versions are possible up to 93 kHz.
- AEC-Q 100 qualification
- ASIL ready device
- Additional functional safety features e.g.:
 - Power-on self-test
 - Monitoring of bias, undervoltage, and current level
 - Overtemperature shut-down
 - Output current limitation
- Wide junction temperature range from -40 $^{\circ}$ C to 170 $^{\circ}$ C, especially designed for operation in harsh environments
- Magnetic characteristics are robust against mechanical stress
- Broad variety of temperature-compensated constant switching points
- For TO92UA package, please contact Micronas service

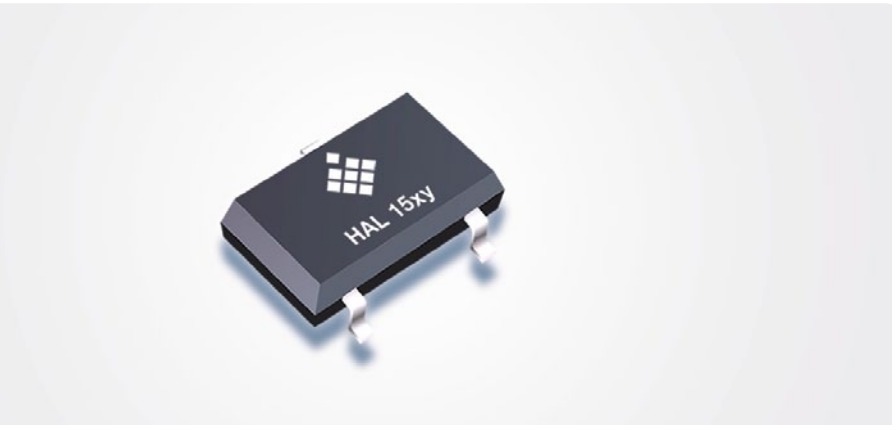

The HAL 15xy family consists of different Hall switches containing a temperature-compensated Hall plate with active offset compensation and comparator, available optionally with open-drain or current output.

As global Hall switch supplier with long-term experience since 1993, 1.5 billion automotive switches shipped and leading expertise in high-quality Hall-effect sensor solutions, Micronas expands its large switch portfolio with the new HAL 15xy family. All CMOS wafer processing is done in Micronas' facilities in Freiburg (Germany) to ensure best quality control and highest flexibility.

As improved successor of the well-known HAL 5xy family, the HAL 15xy is available as 3-wire version with short-circuit protected open-drain output and 2-wire version with current output. HAL 15xy is available in the smallest SOT23 JEDEC package and provides lowest power consumption, fast response times, and special safety features like a unique power-on self-test for greater customer benefit at an excellent price-performance ratio.

With different switching-point versions, the HAL 15xy switch family serves a broad variety of Automotive and Industrial applications under harshest temperature conditions.

HAL 15xy fulfills the latest quality and functional safety standards as AEC-Q100 qualified and ASIL ready device, enabling our customers to target even the most safety-critical applications.

Application Examples

The HAL 15xy is the optimal system solution for applications, such as:

- Endposition detection
- Brushless DC motor commutation
- Revolutions per minute (RPM) or other counting measurements

HAL 4xy

Pre-configured Linear Hall-Effect Sensor IC
in CMOS Technology



Features

- Wide temperature range
 $T_J = -40\text{ °C}$ to 170 °C (HAL 401 only)
- Offset compensation at 147 kHz switching speed
- Low magnetic offset
- Extremely sensitive
- Operates from 4.8 to 12 V (HAL 401), 4.9 to 5.1 V (HAL 411) supply voltage
- Overvoltage protection
- Reverse-voltage protection of VDD pin
- Differential output
- Accurate absolute measurements of DC and low-frequency magnetic fields
- On-chip temperature compensation

Functions

- Current measurement
- Linear movement detection

Generic Applications

- Rotary position
- Leveling

Application Examples

- Potentiometer replacement



The HAL 4xy family represents Hall sensors that include a temperature-compensated Hall plate with chopper offset compensation, two linear output stages, and protection devices.

The output voltage is proportional to the magnetic flux density through the Hall plate. The chopper offset compensation leads to stable magnetic characteristics over supply voltage and temperature.

The HAL 4x1 family can be used for magnetic field measurements, current measurements, and detection of any mechanical movement. Accurate angle measurements or distance measurements can also be done. The sensor is very robust and can be used in electrical and mechanical hostile environments.

The sensors are designed for automotive and industrial applications and operate in the junction temperature range from -40 °C up to 170 °C (HAL 401), -40 °C up to 100 °C (HAL 411) and are available in the SMD package SOT89B.

HAL 81x, HAL 825

High-Precision Programmable Hall-Effect Sensors

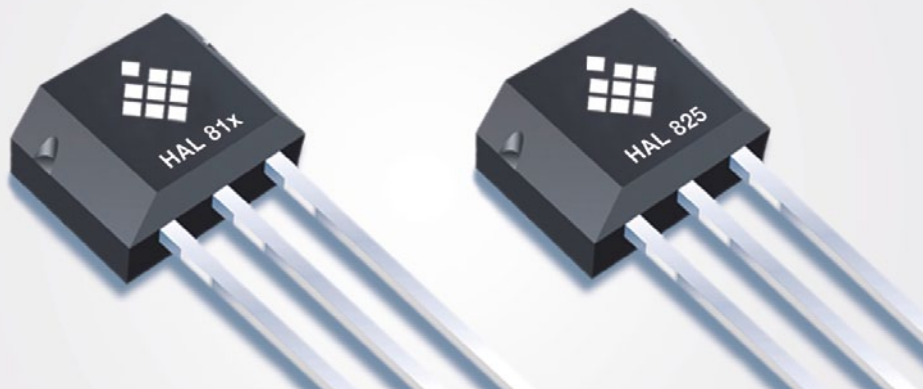

Features

- High-precision linear Hall-effect sensors with digital signal processing
- PWM output signal (125 Hz refresh rate) with up to 11 bit resolution (HAL 810)
- D/A converter with output driver (HAL 817)
- 12-bit ratiometric analog output or 14-bit multiplex analog output (HAL 825)
- Multiple programmable magnetic characteristics in EEPROM with redundancy and lock function
- Ground and supply line break detection
- Programming an individual sensor within several sensors in parallel
- Programming via modulation of V_{SUP}
- Temperature characteristics programmable for matching all common magnetic materials
- Operation with $V_{SUP} = 4.5\text{ V to }5.5\text{ V}$
- Operation with static magnetic fields and dynamic magnetic fields
- Overvoltage and reverse-voltage protection at all pins
- Magnetic characteristics extremely robust against mechanical stress
- Short-circuit protected push-pull output
- EMC and ESD optimized design

Applications

HAL 81x and HAL 825 are optimal system solutions for applications such as:

- Linear movement
- Current measurement
- Potentiometer replacement
- Accelerator pedal
- Throttle position
- Steering torque
- Exhaust gas recirculation

The HAL 810, HAL 817 and HAL 825 are programmable linear Hall-effect sensors which can be used for angle or distance measurements. The major characteristics are programmable in a non-volatile memory.

The HAL 817 has a ratiometric output characteristic; its output voltage is proportional to the magnetic flux and the supply voltage. The HAL 810 provides a pulse-width modulated (PWM) output signal.

The HAL 825 provides either a ratiometric analog output signal or a multiplexed analog output. In multiplex analog output mode, the sensor transmits LSN and MSN of the output value separately. This enables the sensor to transmit a signal with 14-bit accuracy. The sensor is designed to fulfill high requirements in respect of low temperature drifts of sensitivity and offset.

The sensors feature a temperature-compensated Hall plate with chopper offset compensation, an A/D converter, an EEPROM memory with redundancy and lock function for the calibration data and protection devices at all pins. Due to the digital signal processing, analog offsets, temperature shifts, and mechanical stress do not degrade the sensor accuracy.

The tolerances of the sensor, the magnet, and the mechanical positioning can be compensated via programming by customer/user in the final assembly. This offers a low-cost alternative for all applications that presently need mechanical adjustment or laser trimming for calibration.

The HAL 810 and HAL 817 are designed for hostile automotive and industrial applications and operate with a supply voltage of typically 5 V in the junction temperature range from -40 °C up to 170 °C .

The sensors are available in the very small leaded packages TO92UT.

Note: HAL 805, HAL 810 and HAL 815 are not recommended to be used for new designs. HAL 830 can replace the HAL 805 and the HAL 815. HAL 835 can replace the HAL 810.

HAL 83x, HAC 830

Robust Multi-Purpose Linear Hall-Effect Sensors

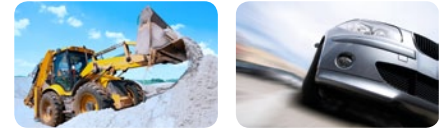

Features

- High-precision linear Hall-effect sensor with 12-bit analog output
- Programmable temperature compensation for sensitivity
- Open-circuit (ground and supply line break) detection with 5 k Ω pull-up and pull-down resistor, overvoltage and undervoltage detection
- Programmable clamping function
- Programming and operation of multiple sensors at the same supply line
- High immunity against ESD
- Operates from 4.5 V up to 5.5 V supply voltage in specification and functions up to 8.5 V
- Overvoltage and reverse-voltage protection at all pins, short-circuit protected push-pull output
- Magnetic field measurement range from ± 15 mT up to ± 150 mT (HAL 835)
- Flexible analog / PWM output (HAL 835)
- Programmable low-pass filter at 80 Hz (less noise) or 2 kHz (faster response) (HAL 835)
- Offset drift over temperature less than $\pm 0.2\%$ of V_{SUP} ($\pm 0.1\%$ for HAL 835)
- Integrated capacitors for improved electromagnetic compatibility (EMC) and PCB-less applications (HAC 830)

Applications

The HAL 83x is the optimal system solution for applications such as:

- Linear movement
- Angle detection
- Accelerator pedal
- Throttle position
- Steering torque
- Exhaust gas recirculation
- Turbo charger

Note: HAL 830 can replace HAL 805, HAL 815 or HAL 817. HAL 835 can replace HAL 810 or HAL 825

The new HAL 83x family consists of robust multi-purpose Hall sensors for linear displacement and angle detection below 90°. They offer flexibility thanks to the analog and PWM output as well, as to the programmable low-pass filter. Due to the high temperature stability, the sensors can be applied in harsh environments and their ability to detect low magnetic fields leads to reduced system costs. All family members are based on Micronas' long success in linear Hall-effect sensors, full in-house manufacturing, and automotive-proven zero ppm track record.

Major characteristics such as magnetic field range, sensitivity, output quiescent voltage and output voltage range are programmable in a non-volatile memory. All sensors feature a temperature-compensated Hall plate with chopper offset compensation, an A/D converter, digital signal processing, a D/A converter with output driver, an EEPROM with redundancy and lock function for the calibration data, a serial interface for programming the EEPROM, and protection devices at all pins.

The sensor can easily be calibrated for perfectly adjusting its output to the input signals and to compensate for any variations in the application (magnet positioning, temperature drift). This enables operation over the full temperature range with high accuracy.

The HAL 83x family is AECQ100 qualified, designed for hostile industrial and automotive applications ($T_J = -40$ °C up to 170 °C) and is available in the very small leaded RoHs package TO92UT. HAC 830 with integrated capacitors is available in the TO92UP package.

HAL 830	Analog output, 30 mT to 100 mT range
HAC 830	Analog output, 30 mT to 100 mT range, integrated capacitors for improved EMC
HAL 835	Analog and PWM output, 15 mT to 150 mT range additional features

HAL 85x

Programmable Hall-Effect Sensors with Arbitrary Output



Features

- Operates from $-40\text{ }^{\circ}\text{C}$ up to $170\text{ }^{\circ}\text{C}$ junction temperature
- High-precision linear Hall-effect sensors with different output formats
- Various programmable magnetic characteristics with non-volatile memory
- Programmable output characteristic (32 setpoints)
- Programmable output formats (PWM or serial Biphase-M)
- Programmable PWM period
- Open-drain output for HAL 855
- Programmable output current source for HAL 856 (low and high current)
- Digital signal processing
- Temperature characteristics programmable for matching all common magnetic materials
- Programming by modulation of the supply voltage
- Lock function and built-in redundancy for EEPROM memory
- Operates from 4.5 V up to 14 V supply voltage
- Operates with static magnetic fields and dynamic magnetic fields up to 2 kHz
- Chopper offset compensation
- Overvoltage protection on all pins
- Reverse voltage protection on V_{DD} pins
- Magnetic characteristics extremely robust against mechanical stress
- Short-circuit protected output
- EMC-optimized design

Applications

Due to the sensor's versatile programming characteristics, the HAL 85x is the optimal system solution for applications such as:

- Linear movement
- Liquid-Level detection



The HAL 85x complement the existing Hall-effect sensor family HAL 8xy. Both universal magnetic field sensors (HAL 855 and HAL 856) provide an arbitrary output signal. The sensors are produced in submicron CMOS technology.

In combination with a rotating or moving magnet, the sensors can be employed for angle, distance, and level measurements. The sensors provide either a pulse-width modulated (PWM) output signal or a serial Biphase-M output.

Major characteristics like magnetic field range, output characteristic, output format sensitivity, shift (duty cycle of the PWM output signal or the serial output word), PWM period, low and high current, and the temperature coefficients can easily be adjusted to the magnetic circuit (linear and quadratic) by programming the non-volatile memory. The output characteristic can be set via 32 setpoints.

The sensors were designed to translate a linear magnetic field into an arbitrary output signal or a non-linear magnetic field into a linear output signal.

The sensors are available in the very small leaded package TO92UT.

HAL 880

Programmable Linear Hall-Effect Sensors

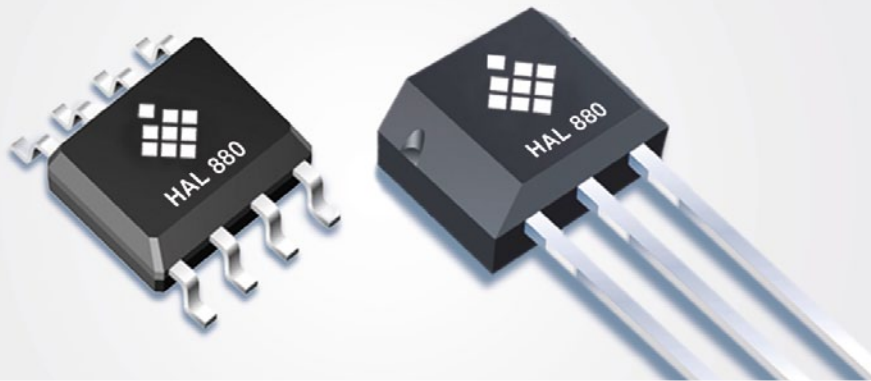

The HAL 880 is designed to fulfill the requirements of today's state-of-the-art applications for linear and angular measurements that require flexibility to compensate system tolerances.

Due to its programmability, it also offers the additional advantage of compensation of system tolerances. This is mandatory for applications like accelerator pedal sensing, current measurement, bending light or head light adjustment. The sensor provides a linear, ratiometric analog output signal with implemented wirebreak detection working with pull-up or pull-down resistor.

Major characteristics like magnetic-field range, sensitivity, VOQ (output voltage at zero magnetic field) and the temperature coefficients can easily be adjusted to the magnetic circuit (linear and quadratic) by programming the non-volatile memory.

The HAL 880 is qualified according to AECQ100 and is available in the leaded package TO92UT or in the SMD package SOIC8.

Features

- Operates from $-40\text{ }^{\circ}\text{C}$ up to $140\text{ }^{\circ}\text{C}$ junction temperature
- Sensitivity drift over temperature less than $\pm 6\%$
- Offset drift over temperature less than $\pm 15\text{ }\mu\text{T/K}$
- Integral non-linearity error of output signal $\pm 1\%$ of V_{DD}
- Ratiometric error of output signal $\pm 1\%$
- Low output noise of 25 mV peak-peak
- Wire-break detection with $5\text{ k}\Omega$ pull-up or pull-down resistor
- Four programmable magnetic ranges: ± 30 , ± 60 , ± 80 , and $\pm 100\text{ mT}$
- Two programmable 3 dB filter frequencies: 500 Hz and 1 kHz
- Programmable sensitivity and offset (VOQ)
- 12-bit ratiometric analog output
- Digital signal processing
- Temperature characteristics programmable to match all common magnetic materials
- 13 customer data bits
- Programming by modulation of the supply voltage
- Operates from 4.5 V up to 5.5 V supply voltage
- Magnetic characteristics extremely robust against mechanical stress

Functions

The HAL 880 is the optimal system solution for functions such as:

- Linear movement
- Current measurements

Generic Applications

- Rotary position
- Leveling

HAL 182x

Linear Hall-Effect Sensors – Programmable or with Fixed Sensitivity



Features

- Operates from $-40\text{ }^{\circ}\text{C}$ up to $170\text{ }^{\circ}\text{C}$ junction temperature
- Linear Hall-effect sensor with ratio-metric analog output
- Various programmable magnetic characteristics with non-volatile memory (HAL 1820)
- Digital signal processing
- Continuous measurement ranges from $\pm 20\text{ mT}$ to $\pm 160\text{ mT}$
- Temperature characteristics programmable for matching all common magnetic materials
- Programming via supply voltage
- Lock function and built-in redundancy for EEPROM memory
- Operates from 4.5 V up to 5.5 V supply voltage
- Operates with static magnetic fields and dynamic magnetic fields up to 2.25 kHz
- Overvoltage and reverse-voltage protection on VDD pin
- Magnetic characteristics extremely robust against mechanical stress
- Short-circuit protected output

Type	Sensitivity [mV/mT]
HAL 1820	programmable
HAL 1821	50
HAL 1822	31.25
HAL 1823	25

Applications

HAL 182x is the optimal system solution for applications such as:

- Linear movement
- Distance measurements
- Current measurements
- Gear position sensor

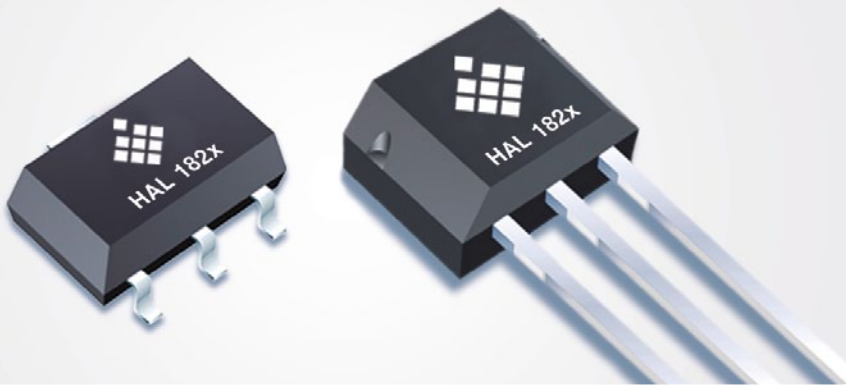

HAL 182x consists of universal magnetic field sensor with a linear analog output based on the Hall effect. The ICs can be used for angle and linear measurements if combined with a rotating or moving magnet. The major characteristics of the HAL 1820 such as magnetic field range, sensitivity, offset (output voltage at zero magnetic field) and the temperature coefficients are programmable in a non-volatile memory. The sensors HAL 1821, HAL 1822, and HAL 1823 have a fixed sensitivity.

The HAL 1820 is programmable by modulating the supply voltage of the sensor. No additional programming pin is needed. The easy programmability allows a 2-point calibration by adjusting the output signal directly to the input signal (like mechanical angle, distance or current). Individual adjustment of each sensor during the customer's manufacturing process is possible. With this calibration procedure, the tolerances of the sensor, the magnet and the mechanical positioning can be compensated in the final assembly.

This offers an alternative for all applications that presently need mechanical adjustment or laser trimming for calibrating the system. The sensors are designed to be used in automotive or industrial applications. They operate in a wide junction temperature range from $-40\text{ }^{\circ}\text{C}$ up to $170\text{ }^{\circ}\text{C}$.

The sensors are qualified according to AECQ100 and are available in the very small leaded package TO92UA and in the small SMD package SOT89B for industrial applications only.

HAL 24xy/HAR 24xy

Precise and Robust Programmable Linear Hall-Effect Sensors
– Single and Dual-Die

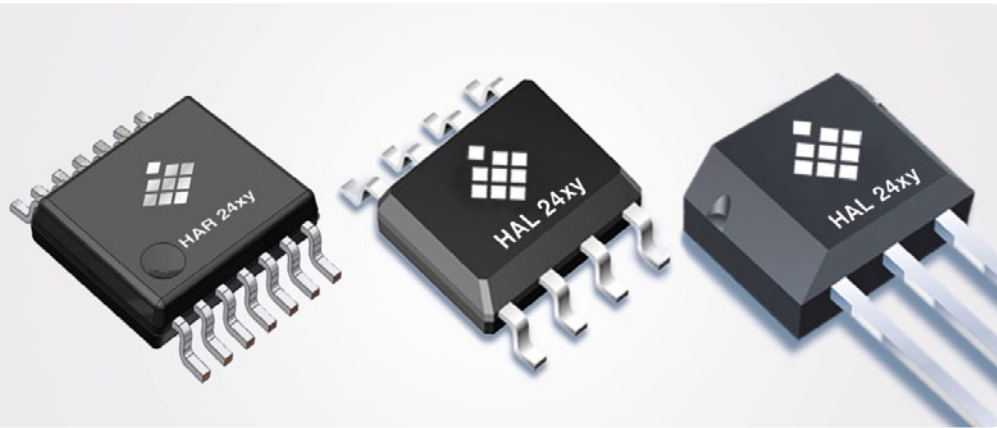

The new HAL/HAR 24xy family consists of single and Dual-Die versions. It offers extended distance measurement, improved robustness state-of-the-art diagnostic functions, and true redundancy (HAR 24xy only) for applications under stringent conditions.

All family members are based on Micronas' long success in linear Hall-effect sensors, full in-house manufacturing and automotive-proven 0 ppm track record. It uses Micronas' latest technology node, a new digital architecture, as well as further enhanced Hall plates. The sensor provides improved output linearization by incorporating a flexible compensation function with 16 programmable setpoints. In addition, angles up to 180° can be measured even with a simple magnet configuration.

The major characteristics like magnetic field range, sensitivity, output quiescent voltage and output voltage range are programmable in a non-volatile memory. All sensors feature a temperature-compensated Hall plate with spinning current offset compensation, an A/D converter, digital signal processing, a D/A converter with output driver, an EEPROM with redundancy and lock function for the calibration data, a serial interface for programming the EEPROM, and protection devices at all pins.

The sensor can easily be calibrated to perfectly adjust its output to input signals and to compensate any variations in the applications (magnet positioning, temperature drift). This enables operation over the full temperature range with high accuracy. The calculation of the individual sensor characteristics and the programming of the EEPROM can easily be done with a PC and the application kit from Micronas.

The sensor is designed for hostile industrial and automotive applications and operates from $T_J = -40\text{ °C}$ to 170 °C .

The HAL/HAR 24xy family is qualified according to AECQ100 and it is available in the very small leaded RoHs package TO92UT and in the SOIC8 SMD package.

Features

- High-precision linear Hall-effect sensor with ratiometric 12-bit analog output
- 16 setpoints for various output signal characteristics (HAL 2425), HAL 2455)
- High immunity against ESD (8 kV)
- Multiple customer-programmable magnetic characteristics in EEPROM with redundancy and lock function
- Programmable temperature compensation for sensitivity and offset
- Magnetic field measurements in the range up to 200 mT
- Low output voltage drifts over temp.
- Open-circuit (ground and supply line break detection), overvoltage and undervoltage detection
- Programmable output clamping function
- Digital readout of temperature and magnetic field information in calibration mode
- Operates from 4.5 V up to 5.5 V supply voltage in specification
- Operates with static magnetic fields and dynamic magnetic fields up to 2 kHz
- Overvoltage and reverse-voltage protection at all pins
- Short-circuit protected push-pull output

Applications

The HAL/HAR 24xy is the optimal system solution for applications such as:

- Angular measurement: throttle position, pedal position, steering torque, and EGR applications
- Distance and linear movement measurements in safety critical applications (HAR 24xy)

Family Overview

HAL 2420	2-point calibration
HAL 2425	2-point calibration, 16 setpoints linearization
HAL 2455	PWM output (up to 2 kHz) 16 setpoints linearization
HAR 2425	Dual-Die version of HAL 2425
HAR 2455	Dual-Die version of HAL 2455

HAL 28xy

Linear Hall-Effect Sensor Family with Digital Interfaces



Features

- Operating junction temperature range: -40 °C up to 170 °C
- High-precision linear Hall-effect sensor
- Spinning-current offset compensation
- Built-in temperature sensor
- Built-in RISC processor
- Digital signal processing
- Up to 12 bit resolution
- Customer-programmable temperature compensation of Hall sensitivity (2nd order) and Hall offset (1st order)
- Different interface options:
 - SENT
 - PWM output up to 2 kHz (HAL 2850)
- Magnetic characteristics extremely robust against mechanical stress
- Non-volatile EEPROM with redundancy and lock function

The HAL 28xy family consists of members with different digital interfaces, like PWM and SENT (SAE J2716). The built-in RISC processor allows a fast implementation of new output formats or customer-specific signal processing.

All members within this family can be programmed without any additional programming pin. Programming is done via BiPhase-M telegrams. Upon request, especially where in-system programming by the customer is not possible, pre-configured versions can be derived.

The HAL 28xy family features a Hall plate with spinning current offset compensation technique and a precise temperature sensor which is used for temperature compensation of both the Hall sensors' sensitivity and offset. The sensors' signal path is handled by the RISC processor. This is of great benefit because analog offsets, temperature shifts, and mechanical stress do not degrade the digital signals.

Major characteristics like magnetic field range, sensitivity, offset and the temperature coefficients of sensitivity and offset can easily be adjusted to the magnetic circuit by programming the non-volatile memory. Furthermore, the individual devices can also be obtained as pre-configured versions with defined settings as per customer requirements.

The HAL 28xy family is qualified according to AECQ100 and is available in the very small leaded package TO92UT.

Type	Resolution	Pulse Pause	SENT version
HAL 2830	12 bit	No	SAE-J2716 release 2010-01
HAL 2831	16 bit	No	SAE-J2716 release 2010-01
HAL 2832	12 bit	Yes	SAE-J2716 release 2010-01
HAL 2833	16 bit	Yes	SAE-J2716 release 2010-01

Functions

Due to the sensors' versatile programming characteristics and low drifts, the HAL 28xy family is the optimal system solution for functions, such as:

- Linear movement
- Current measurement

Generic Applications

- Steering torque
- Turbo charger

3D HAL[®] Technology from Micronas

Two-dimensional Measurement with Vertical Hall Plates

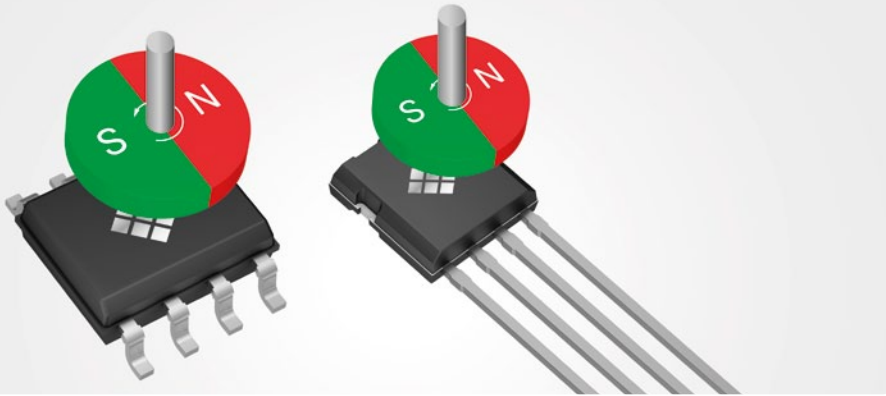

In the area of position detection in Automotive or Industrial applications, the requirements to sensors are steadily increasing. Their accuracy and reliability in harsh environments has to grow steadily. For applications measuring small distances (up to 6 mm) or small angle ranges (up to 60°), established linear (1D) Hall-effect sensors could show excellent and reliable performance.

For larger ranges, a new technology is needed. To this end, Micronas has developed the new Hall-effect sensor family HAL 3xyz. With this family, angle measurements, formerly only to be done with on-chip flux concentrators or complex dual-package AMR (Anisotropic Magneto Resistance) sensors, can now be implemented in a CMOS process. Contrary to the AMR technology, measurements of angles up to 360°, as well as linear distances can both be realized.

The HAL 3xyz family represents a new level of performance for Hall-effect sensors enabling a significant simplification in the design of magnetic systems. The sensors are based on Micronas' innovative 3D HAL technology. A major advantage of this technology is the use of the so-called pixel cell. It consists of a combination of two vertical and one horizontal Hall plate. With this pixel cell it is possible to measure the three magnetic field vector components at one spot. Magnetic field lines parallel to the sensor surface are measured by the vertical Hall plates, whereas the component perpendicular to the chip surface is measured by the horizontal Hall plate. The measurement of the relative strength of both components is the key for the excellent angular performance. Even a varying distance between magnet and sensor does not prevent a stable output signal. Also temperature effects are mainly suppressed by relative measurements of the two components.

The combination of vertical and horizontal Hall plates enables robust linear position measurements with reduced magnet sizes. Using a magnet with a length of 10 mm, distances of ≥ 15 mm can be easily achieved. Overall 40 mm movement can be realized with simple magnetic setups.

Overall, the various family members support different output formats like ratiometric analog, PWM and SENT. The devices can be easily adapted to the different applications by providing easy programmability. Key parameters like offset, gain, zero angle, output offset and gain, 33 setpoints for linearization and clamping levels can be stored in the built-in memory.

Today, the whole product family consists of the first generation devices HAL 36xy and HAL 38xy, as well as of the recently launched second generation HAL 37xy featuring further improved angular performance.

HAL 36xy

Programmable Hall-Effect Sensor Family for Rotational Position Detection based on 3D HAL® Technology



The HAL 36xy family represents the first generation of angle sensors based on Micronas' innovative 3D HAL technology – enabling a significant simplification in the design of magnetic systems while reaching a new level of performance for Hall-effect sensors. The HAL 36xy family is targeted for rotational position detection up to 360°.

The devices of this family measure the X and Y component of a magnetic field in the sensor plane. Monitoring the relative strength of both components leads to a stable output even if the distance between magnet and sensor varies. The result is angular position measurement from 0° to 360° with very high accuracy over a wide temperature range. The devices are available with ratiometric analog output (HAL 3625) or PWM output (HAL 3675).

The sensors are housed in a small SOIC8 SMD package and are AECQ100 qualified. They include an integrated wire-break detection feature that works in conjunction with a pull-up or pull-down resistor to detect fault conditions. Internal digital signal processing algorithms in conjunction with integrated non-volatile memory enable customization and robust calibration for application-specific impairments. Easy to use LabVIEW™-based software and high-quality application notes accelerate development, even for novice magnet system designers. The result is a quickly developed, customized sensor system with extremely low temperature drift and insensitivity to air gap variations.

Features

- Operates from –40 °C up to 170 °C junction temperature
- Angular accuracy of better than ±0.75 FS over 360° range (digital output)
- Stable performance with air gap variation
- Programming via output pin
- 12-bit ratiometric analog output (HAL 3625)
- Wire-break detection with pull-up or pull-down resistor
- Lock function and built-in redundancy for EEPROM memory
- Operates from 4.5 V up to 5.5 V supply voltage
- Output response time <0.6 ms
- Overvoltage and reverse-voltage protection on VSUP pin
- Short-circuit protected output
- PWM output with selectable frequencies between 250 Hz and 2 kHz (HAL 3675)
- 32 setpoints for output linearization
- On-board diagnostic features

Functions

HAL 36xy is an optimal system solution for functions such as:

- Rotary movement detection

Generic Applications

- Rotary position

License Note

HAL 36xy/38xy use licenses of Fraunhofer Institute for Integrated Circuits IIS.

HAL 37xy

Programmable Hall-Effect Sensor Family for Rotational or Linear Position Detection based on 3D HAL® Technology



Features

- Measurement extremely robust against temperature and stress influence
- Operating with magnetic field amplitudes down to ± 20 mT with an angular accuracy of $\pm 0.5\%$ FS (digital output, X-Y Hall plates)
- 12 bit ratiometric linear analog output for HAL 372x
- HAL 3715 with modulo $90^\circ/120^\circ$ for chassis systems
- 0.2 kHz to 2 kHz PWM (up to 12 bit) or 12 bit SENT output for HAL 373x
- Programmable arbitrary output characteristic with up to 33 setpoints
- Operates from $V_{SUP} = 4.5$ V up to 5.5 V
- Operates from $T_J = -40$ °C up to 170 °C
- Programming via the sensor's output pin
- Programmable characteristics in EEPROM with redundancy and lock function
- 2nd-order temperature-dependent offset of programmable for X/Y- or Z-channel
- On-board diagnostics
- Short-circuit protected push-pull output
- Over-/reverse-voltage protection at VSUP
- Under- and overvoltage detection at VSUP
- Wire-break detection with pull-up and pull-down resistor

Functions

HAL 37xy provides an optimal system solution for functions such as:

- Rotary movement detection
- Linear movement detection

Applications Examples

- EGR valve position
- Clutch pedal position
- Gear selector
- Cylinder and valve position sensing
- Non-contact potentiometer

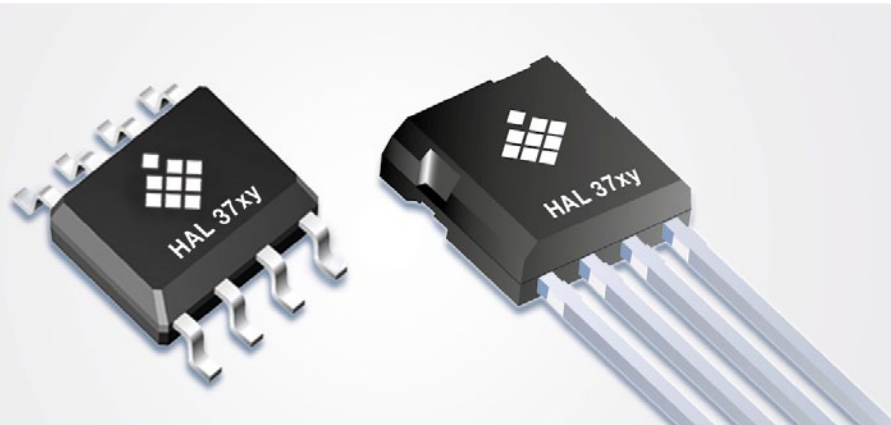

The HAL 37xy family is the second sensor generation using Micronas' proprietary 3D HAL technology. The second generation of the 3D HAL technology leads to a further improvement of the angular performance. Compared to the first generation, a 30% lower angular error has been achieved.

Operation with magnetic fields down to ± 20 mT is enabled thanks to the improved technology. HAL 3715 / HAL 372x provide a linear, ratiometric analog output signal with integrated wire-break detection working with pull-up or pull-down resistor. HAL 373x features digital output formats such as PWM and SENT SAE J2716 rev. 2010. The digital output format is customer programmable.

The sensors can measure three magnetic field components B_x , B_y , and B_z . This enables a set of potential applications for position detection, such as wide distance, angle or through-shaft angular measurements. On-chip signal processing calculates the angle out of two magnetic field components and converts this value into an output signal. The sensor exhibits excellent drift performance over the specified temperature range resulting in a new class of accuracy for angular or linear measurements. The sensor features an arbitrary programmable linear characteristic for linearization of the output signal. Major characteristics can be adjusted to the magnetic circuitry by programming the non-volatile memory.

The sensor contains advanced on-board diagnostic features that enhance fail-safe detection. The devices are designed for Automotive and Industrial applications and operate in the junction temperature range from -40 °C up to 170 °C. The sensors are available in the very small four-pin leaded transistor package TO92UP, as well as in the SOIC8 package.

HAL 38xy

Programmable Hall-Effect Sensor Family for Linear Position Detection based on 3D HAL[®] Technology



Features

- Operates from -40 °C up to 170 °C junction temperature
- Stable performance with air gap variation
- Programming via output pin
- 12-bit ratiometric analog output (HAL 385x)
- Wire-break detection with pull-up or pull-down resistor
- Lock function and built-in redundancy for EEPROM memory
- Operates from 4.5 V up to 5.5 V supply voltage
- Output response time <0.6 ms
- Overvoltage and reverse-voltage protection on V_{SUP} pin
- Short-circuit protected output
- PWM output with selectable frequencies between 250 Hz and 2 kHz (HAL 3875)
- 32 setpoints for output linearization
- On-board diagnostic features

Functions

HAL 385x/387x provides an optimal system solution for functions such as:

- Linear movement detection

Applications Examples

- EGR valve position
- Clutch pedal position
- Gear selector
- Cylinder and valve position sensing
- Non-contact potentiometer

License Note

HAL 36xy/38xy use licenses of Fraunhofer Institute for Integrated Circuits IIS.



The HAL 38xy family represents the first generation of angle sensors based on Micronas' innovative 3D HAL technology – enabling a significant simplification in the design of magnetic systems while reaching a new level of performance for Hall-effect sensors. The HAL 38xy targets extended linear movement detection up to 40 mm and off-axis angular position detection in the range from 0° to 360°.

The devices of this family measure either the X or Y component in conjunction with the Z-component of a magnetic field. Together with its 32-setpoint linearization feature, this family offers superior system performance for extended linear movement detection while using small magnet circuitry. HAL 385x provides a ratiometric analog output and HAL 387x features a programmable PWM output.

The sensors are housed in a small SOIC8 SMD package and are AECQ100 qualified. They include an integrated wire-break detection feature that works in conjunction with a pull-up or pull-down resistor to detect fault conditions. Internal digital signal processing algorithms in conjunction with integrated non-volatile memory enable customization and robust calibration for application-specific impairments. Easy to use LabVIEW[™]-based software and high-quality application notes accelerate development, even for novice magnet system designers. The result is a quickly developed, customized sensor system with extremely low temperature drift and insensitivity to air gap variations.

CUR 3105, CUR 3115

Hall-Effect Current Sensors with Analog Output



Features

- High-precision current sensor with ratiometric output and digital signal processing
- Low output voltage drifts over temperature
- 12-bit analog output
- Multiple programmable magnetic characteristics in a non-volatile memory (EEPROM) with redundancy and lock function
- Open-circuit (ground and supply line break detection) with 5 k Ω pull-up and pull-down resistor, overvoltage and undervoltage detection
- For programming an individual sensor within several ICs in parallel to the same supply voltage, a selection can be done via the output pin
- Programmable clamping function
- Programming through modulation of the supply voltage
- Operates from 4.5 V up to 5.5 V supply voltage in specification and functions up to 8.5 V
- Operates with static magnetic fields and dynamic magnetic fields up to 1 kHz
- Overvoltage and reverse-voltage protection at all pins
- Magnetic characteristics extremely robust against mechanical stress
- Short-circuit protected push-pull output
- “Die down” SOIC8 package allowing short distance between conducting medium and the sensitive area (CUR 3115 only)

Generic Applications

Due to the sensors' versatile programming characteristics and low drifts, CUR 3105 and CUR 3115 are optimal system solutions for contactless current measurement applications.

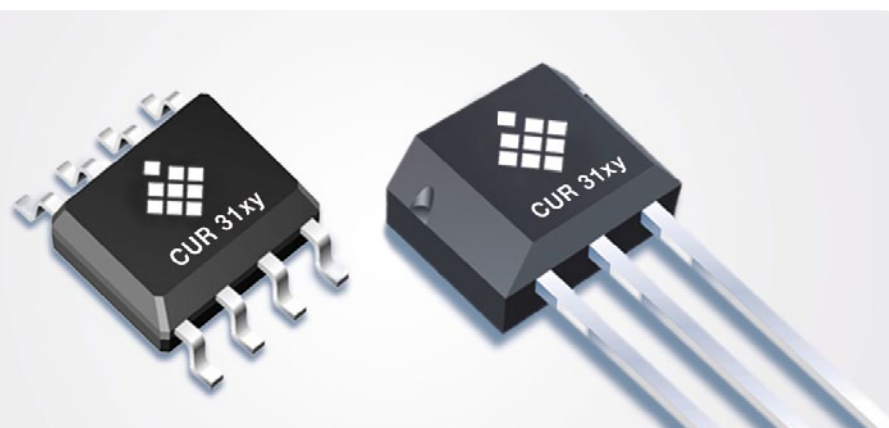

CUR 3105 and CUR 3115 represent the first members of the new Micronas product group of Hall-effect-based current sensors. They can be used for very precise current measurements. The output voltage is proportional to the measured current and the supply voltage (ratiometric analog output). Major characteristics, such as magnetic field range, sensitivity, output quiescent voltage (output voltage at $B=0$ mT) and output voltage range are programmable and are stored in the internal EEPROM.

CUR 3105 and CUR 3115 feature a temperature-compensated Hall plate with chopper offset compensation, an A/D converter, digital signal processing, a D/A converter with output driver, an EEPROM memory with redundancy and lock function, a serial programming interface, and protection devices at all pins. The internal digital signal processing is of great benefit because analog offsets, temperature shifts and mechanical stress do not degrade the sensor's accuracy.

CUR 3105 and CUR 3115 are programmable by modulating the supply voltage. No additional programming pin is needed. Individual adjustment of each sensor during the customer's manufacturing process is possible. With this calibration procedure, the tolerances of the IC and the mechanical positioning can be compensated in the final assembly.

The sensors are designed for automotive, white goods and industrial applications and operates with typically 5 V supply voltage in the wide junction temperature range from -40 °C up to 170 °C.

CUR 3105 is available in the very small leaded package TO92UT and the SMD package SOIC8. CUR 3115 is available in the SMD package SOIC8 only. Both devices are qualified according to AECQ100.

Tool Chain for Hall-Effect Sensors and Current Sensors



USB-Programming-Kit V1.01

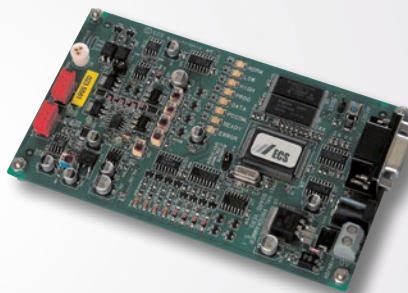

HAL APB V5.1



HAL APB V1.5

Micronas provides three dedicated programmer boards supporting all programmable sensors. These three programmer boards are used as a general-purpose programming interface, which is capable of addressing all programmable Micronas Hall-effect sensor families within the Micronas sensor portfolio.

The application board V1.5 (APB) can be used for the products HAL 18xy, HAL 24xy, HAR24xy, HAL 28xy, HAL 36xy, HAL 37xy, and HAL 38xy.

The application board V5.1 supports the following products: HAL 810, HAL 817, HAL 82x, HAL 83x, HAL 85x, HAL 880, HAL 100x, and CUR 31xy.

Both boards provide an application software supporting a command interface for the communication with a PC. This allows the implementation of specific PC software for engineering purposes or in-line calibration.

The new HAL USB-Kit V1.01 is intended for lab/engineering purposes only. This programming kit can be used for the products HAL 18xy, HAL 24xy, HAR24xy, HAL 36xy, HAL 37xy, and HAL 38xy.

For each of the programmable Hall sensor families, a specific PC software exists. This software provides a graphical user interface based on LabVIEW™ on a PC.

mySENS®

CCFET Gas Sensing Technology

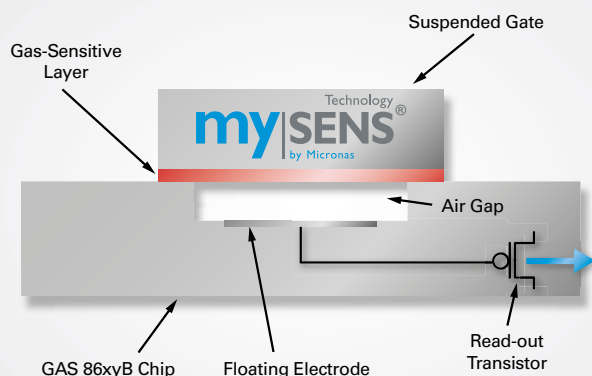

Micronas gas sensors are based on a unique and proprietary technology called mySENS®. The special feature distinguishing Micronas devices from others is their special CCFET setup. The CCFET technology (Capacitive-Coupled Field-Effect Transistor) is the way, our sensors detect gas concentration changes in the ambient air for a broad variety of applications.

For the detection of a target gas, a gas-sensitive layer is applied on a suspended gate that is mounted on top of a silicon chip. If this layer comes into contact with molecules of the target gas it responds with a change of its surface potential. As shown in the illustration, the gas-sensitive layer is capacitively coupled to a large floating electrode which is connected to the floating gate of a conventional MOSFET (Metal Oxide Semiconductor Field-Effect Transistor). Any gas-induced change of the gas-sensitive layer's surface potential is detected by the MOSFET and digitally processed by the integrated electronics.

What makes this way of gas detection so special? The interaction between the gas-sensitive layer and ambient gas molecules is a reversible dynamic process. This process takes place at room temperature allowing low-power, unheated operation for many gas species. All of this occurs without wear of the gas-sensitive layer. By using different gas-sensitive layers, Micronas gas sensors are able to detect specific target gases like nitrogen dioxide (NO₂), ammonia (NH₃), hydrogen (H₂) and volatile organic compounds (VOC).

Technology

- Versatile, integrated digital gas sensor technology
- CCFET technology for gas detection
- No heating required for most target gases
- Fast detection of concentration changes of selected ambient trace gases
- Adjustable detection spectrum (by sensing layer and algorithms)
- Fabrication process embedded into Micronas' CMOS manufacturing technology
- Immunity against environmental interference, low cross-sensitivities

Advantages

GAS 86xyB is the optimal system solution for:

- Detection of concentration changes of ambient trace gases
- Upgrading temperature and relative humidity based applications with gas detection

Information

- Explore mySENS® technology: <http://www.micronas.com>
- For more information about Micronas gas sensors please email: mySENS@micronas.com

GAS 86xyB

Multi-Parametric Gas Sensor Platform with SPI-Output



Features

- Operates from $-40\text{ }^{\circ}\text{C}$ up to $85\text{ }^{\circ}\text{C}$ ambient temperature
- Operates from 5% up to 95% relative humidity
- Robust against overdose exposure
- Low cross-sensitivities
- Two independent gas sensor units
- Integrated temperature sensor
- Integrated relative humidity sensor
- Electronic self-test capability
- Digital signal processing
- Integrated EEPROM
- Digital SPI interface
- Integrated heating option
- 2.7 to 3.6 V operating voltage
- Measurement ranges from approx. 100 ppb to 1% gas concentration (exact values vary by target gas)
- Target gases NO_2 , NH_3 , H_2 , and VOC (volatile organic compounds)
- Low current consumption (average operation $<10\text{ }\mu\text{A}$)
- Product life time >10 years
- Small $8\times 6\text{ mm}$ QFN sensor package with integrated PTFE particle filter

Functions

- The GAS 86xyB is the optimal system solution for:
 - Air Quality Control
 - Comfort and energy efficiency in building and cabin automation: HVAC, IAQ
 - Fire Detection
 - Early fire detection (small size or built-in) with less false alarms
 - Leakage Detection
 - NH_3 leakage detection (alternative coolant, farming)
 - H_2 leakage detection (fuel-cell facilities, fuel-cell vehicles, hydrogen installations, battery charge control)

GAS 86xyB is a multi-parametric sensor platform for gas detection based on the mySENS[®] technology from Micronas. The capabilities of the GAS 86xyB platform go far beyond the measurement of a single gas species. Embedded into Micronas' CMOS manufacturing technology, GAS 86xyB includes two individual CCFET gas sensing devices, a temperature sensor, a relative humidity sensor, and electronic components, such as amplifiers, digital signal processing unit (DSP), as well as memory on one single chip.

By choosing the appropriate gas-sensitive layers for the two independent gas sensing devices, the sensor platform is factory-tailored to a specific sensing task. A serial peripheral interface (SPI) is capable of addressing each sensor independently and provides digital values, proportional to the measurement results. The factory-calibrated integrated temperature and relative humidity sensors can be used for cross-sensitivity compensation leading to reliable gas detections. They can also be used for independent temperature and relative humidity measurement purposes.

The sensor platform allows an electric performance check via an intelligent self-test function to guarantee accurate operation. For this function, a dedicated voltage level can be applied to the floating gate allowing the stimulation of an output voltage change without the presence of a target gas. An integrated heater provides the capability of heating the device. This may be needed for special operating conditions or for thermal refreshment e.g. in case of volatile organic compounds (VOC).

Another striking feature of the GAS 86xyB is its unique package. The sensor platform is available in an open-cavity QFN package with the dimensions of only $6\text{ mm} \times 8\text{ mm} \times 1.4\text{ mm}$ (length \times width \times height). An implemented polytetrafluorethylene (PTFE) filter on the open cavity avoids particle contamination of the sensor elements.

GAS 86xyB

Multi-Parametric Gas Sensor Platform with SPI-Output

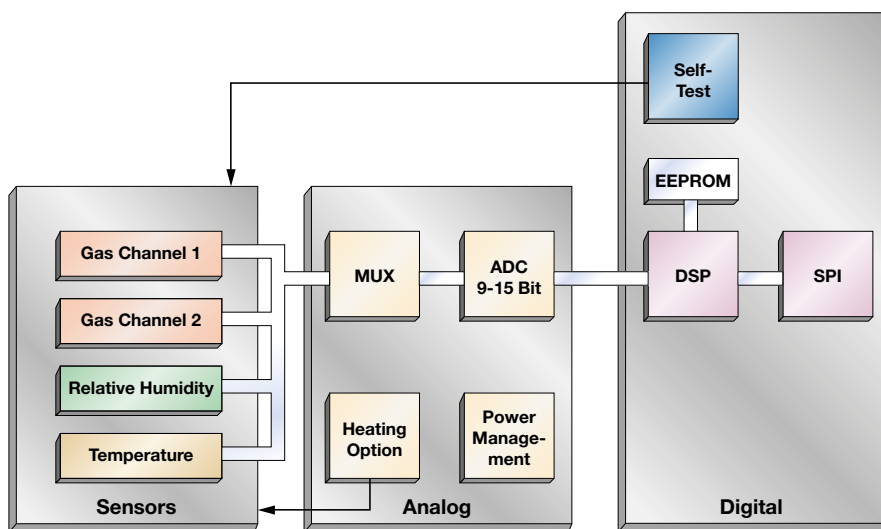

GAS 86xyB Block Diagram

*Built-in self-test capability comprises the complete measurement signal path. The self-test does not require the presence of a target gas.

Tool Chain for GAS 86xyB Sensors

USB Demo Kit

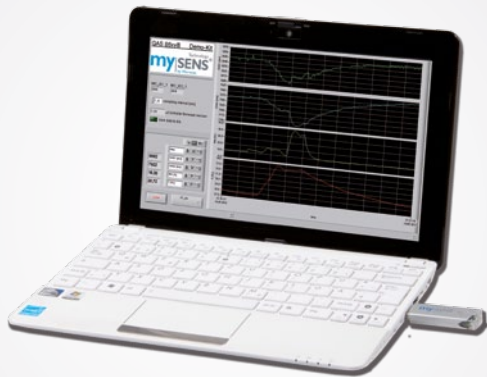

With an easy-to-use plug-and-play USB solution, Micronas provides the fastest way to begin the evaluation of the GAS 86xyB with mySENS technology. You only need a PC with a USB port and the appropriate LabVIEW™ software with graphical user interface (GUI), which can be downloaded from the Micronas Service Portal <https://service.micronas.com>. After installation, you are able to set up the complete GAS 86xyB sensor, to read out and to store the measurement values on your PC.

Features

- For engineering purposes, Micronas offers an easy-to-use demo kit:
- USB microcontroller interface board
- Direct USB connectivity
- LabVIEW™ graphical user interface
- No additional hardware required.
- One hardware for the entire GAS 86xyB product family

Kit content

- USB microcontroller interface board with GAS 86xyB sensor

Application Support

- All required documentation, SW and drivers can be downloaded from the Micronas Service Portal: <https://service.micronas.com>
- For more information about Micronas USB evaluation kit please email to: mySENS@micronas.com



Introduction to Embedded Motor Controllers

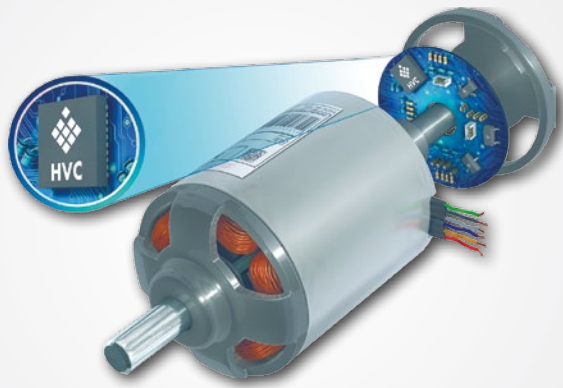

The Micronas high-voltage controller family combines a standard microcontroller core with a wide range of additional functions which, up to now, could only be realized via external circuit elements.

The family is designed as an embedded controller for smart actuators. It features advanced integration for compact and cost-effective system designs for use in automotive applications and beyond (industrial, consumer, instrumentation, etc.).

Replacement of conventional mechanical drive by “on-demand” electric drive and a general adoption of more efficient electrical motors are the main reasons for a growing demand for cost-effective system solutions for electrical motor control and drive. Long lifetime reliability, reduction of weight and overall dimension are additional key issues which have to be addressed especially for automotive applications. Thanks to their better efficiency, lower acoustic- and electrical noise, brushless DC (BLDC) are gaining a significant share of the electrical motors by replacing brushed (BDC) motors.

Micronas’ High-Voltage Controllers integrate almost all surrounding circuits needed for driving electrical motors. In addition to the UART interface, the built-in networking capabilities enable the deployment of LIN bus control compliant to LIN-2.1 for a wider range of applications like e.g. remote smart actuator. Reducing the number of external components to a minimum, the product’s flexible peripherals allow direct controlling of brushless, brush-type DC- and Stepper electrical Motors, either by means of three fully integrated half-bridges or by controlling three external MOSFET half-bridges. Thanks to this flexibility in driving the electrical motor, the HVC controllers provide an effective system solution for both small and medium sized electrical motors, enabling a common product platform. This gives our customers a decisive competitive edge because they are much faster at the implementation stage and need fewer resources in the development process of their various applications.

HVC 4223F

Embedded Motor Controller for Smart Actuators



The new HVC 4223F flex servo-drive from Micronas enables cost-effective realization of powerful and compact DC motor control. Powered by a 32-bit CPU core (ARM® Cortex-M3) and integrating high-performance analog functions, the HVC 4223F economically addresses growing challenges in the automotive market and beyond (industrial, consumer, instrumentation, etc.). The flexible peripherals of the product provide all means to directly control brush-type, stepper (bipolar or three phase), or brushless direct current (BLDC) motors via integrated high-performance half-bridges without the need for external components.

Beside timers/counters, interrupt controller, multichannel A/D converter, SPI, and enhanced PWMs with diagnosis functions, this device contains an advanced LIN UART interface with a LIN 2.1 transceiver with provisions for voltage regulators for direct connection to a 5.4 V to 18 V power supply. The support of various power management modes makes it possible to adjust current consumption according to system needs. The HVC 4223F further features a flash program memory with a size of 32 kbytes, providing high flexibility in code development, production ramp-up, and in-system code update.

Various integrated digital and analog circuit units such as comparators with virtual star point reference, current scaling or an embedded programmable gain amplifier allow users to minimize the number of external components. The computation capacity supports complex motor control algorithms such as Space Vector Modulation (SVM) for permanent magnet synchronous motors (PMSM) in addition to six-step commutation with sensor feedback or sensorless control as well as various stepping configurations.

Features

- Three integrated half-bridges up to 3 x 600 mA
- Temperature range up to $T_J = 150\text{ }^\circ\text{C}$
- Dual-mode Supply voltage: 5.4 V ... 18 V, Load dump up to 40 V
- High-performance 32-bit ARM® Cortex M3, running at up to 20 MHz
2 kbyte RAM
- 32 kbyte Flash
- On-chip NVRAM and oscillators
- Logic modules dedicated for controlling BLDC or BDC motors
- Comparators with integrated virtual star point and reference currents
- Digital and window watchdog timers with different, independent clocks
- 12-bit multi-channel ADC
- Programmable gain amplifier
- 16-bit free-running counter with three capture/compare-modules
- Two 16-bit timers
- Enhanced PWMs (EPWMs), providing edge/center-aligned signals with non-overlapping capability
- SPI and enhanced LIN 2.x UART
- LIN 2.1 transceiver
- Temperature sensor
- Active EMI suppression hardware
- Several diagnosis and protection functions such as:
 - Clock/temperature/supply supervision
 - Internal protection for non-overlapping bridge activation
- Power saving modes

Functions

The HVC 4223F is the enhanced system solution to drive stepper, BLDC and up to two BDC motors for various applications in the automotive environment, like grille shutter, HVAC flaps, LED headlight fan as well as in the industrial environment, enabling smart mechatronical actuators.

HVC 2480B

Embedded Motor Controller for Smart Actuators



Reducing the number of external components to a minimum, the product's flexible peripherals allow direct controlling of brush-type and brushless electrical motors either by means of three fully integrated half-bridges or by controlling three external MOSFET half-bridges. The chip provides an ideal solution for smart actuator and smart sensor applications. Three fully integrated half-bridges allow to directly connect a BLDC motor without the need for external components. Various integrated digital and analog circuit units such as comparators with virtual star point reference or embedded amplifier allow users to minimize the number of external components.

Beside timers/counters, interrupt controller, multichannel A/D converter and enhanced PWMs, the HVC 2480B contains voltages regulators (including a switchable 5 V output to power external HW) for direct 5.4 V ... 18 V operation, as well as LIN PHY, UART and SPI interfaces. This makes the overall system lighter in weight and saves important space within the application.

Features

- Three integrated half-bridges or gate drivers for external half-bridges
- Temperature range up to $T_J = 140\text{ }^\circ\text{C}$
- Supply voltage: 5.4 V ... 18 V
- High-performance 8-bit 8051 core (two-clock machine cycle) running with up to 24 MHz
- 1.75 KByte RAM
- 32 KByte Flash
- On-chip EEPROM (512 Byte) and oscillators
- Logic modules dedicated for controlling BLDC or BDC motors
- Three comparators with integrated virtual star point or external reference
- Multi-channel 10-bit ADC with selectable reference, programmable conversion time, and flexible start of conversion trigger
- Operational amplifier
- Three enhanced PWMs (EPWMs) modules, edge/center-aligned with two independent outputs per module with non-overlapping capability
- Configurable status of I/Os after reset
- Switchable 5 V power supply output
- SPI and enhanced LIN 2.x UART
- LIN 2.1 transceiver
- Temperature sensor
- Active EMI suppression hardware
- Several diagnosis and protection functions such as:
 - Clock/temperature/supply supervision
 - External hardware protection from over-current conditions
 - Internal protection for non-overlapping bridge activation
- Power saving modes
- PQFN40 6x8 mm² package

Functions

The HVC 2480B is the optimal system solution for controlling brush-type and brushless motors, especially for small-form-factor applications

Functions

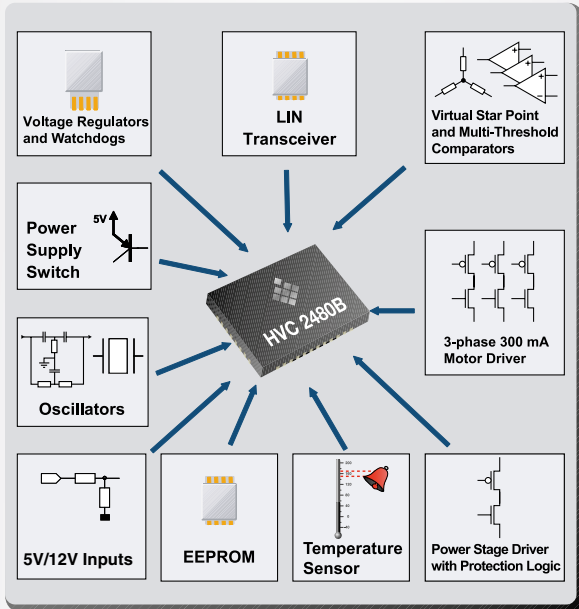

Generic Applications

- Directly driving small motors
- Driving of motors with higher current via external half-bridges
- Sensor or sensorless controlled operation
- Block or sinusoidal (space vector modulation) commutation

Application Examples

Automotive:

- Directly driving BLDC/PMSM motors (up to 300 mA, 600 mA peak): Grille shutter, LED fan, advanced headlight, cooling fan
- Driving of BLDC/PMSM motors with higher current via external half-bridges: Electronic throttle control, EGR, wiper, electric seat, water/oil/fuel pump
- Directly driving up to two BDC motors in H-bridge configuration

Industrial:

- Consumer (printer/scanner, fan/blower)
- Industrial (air sampling/gas analyzer, bar code reader, automation), as well as instrumentation products

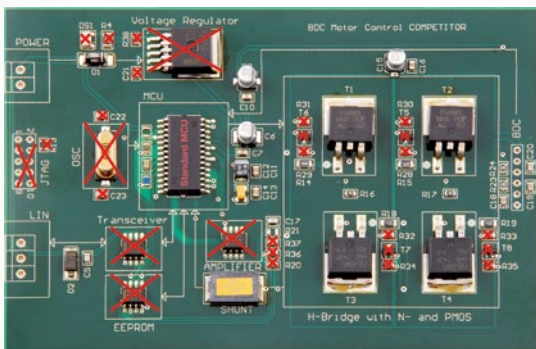

Application example: DC motor control conventional solution



Cost-effective solution with the HVC 2480B

Motor Control Applications

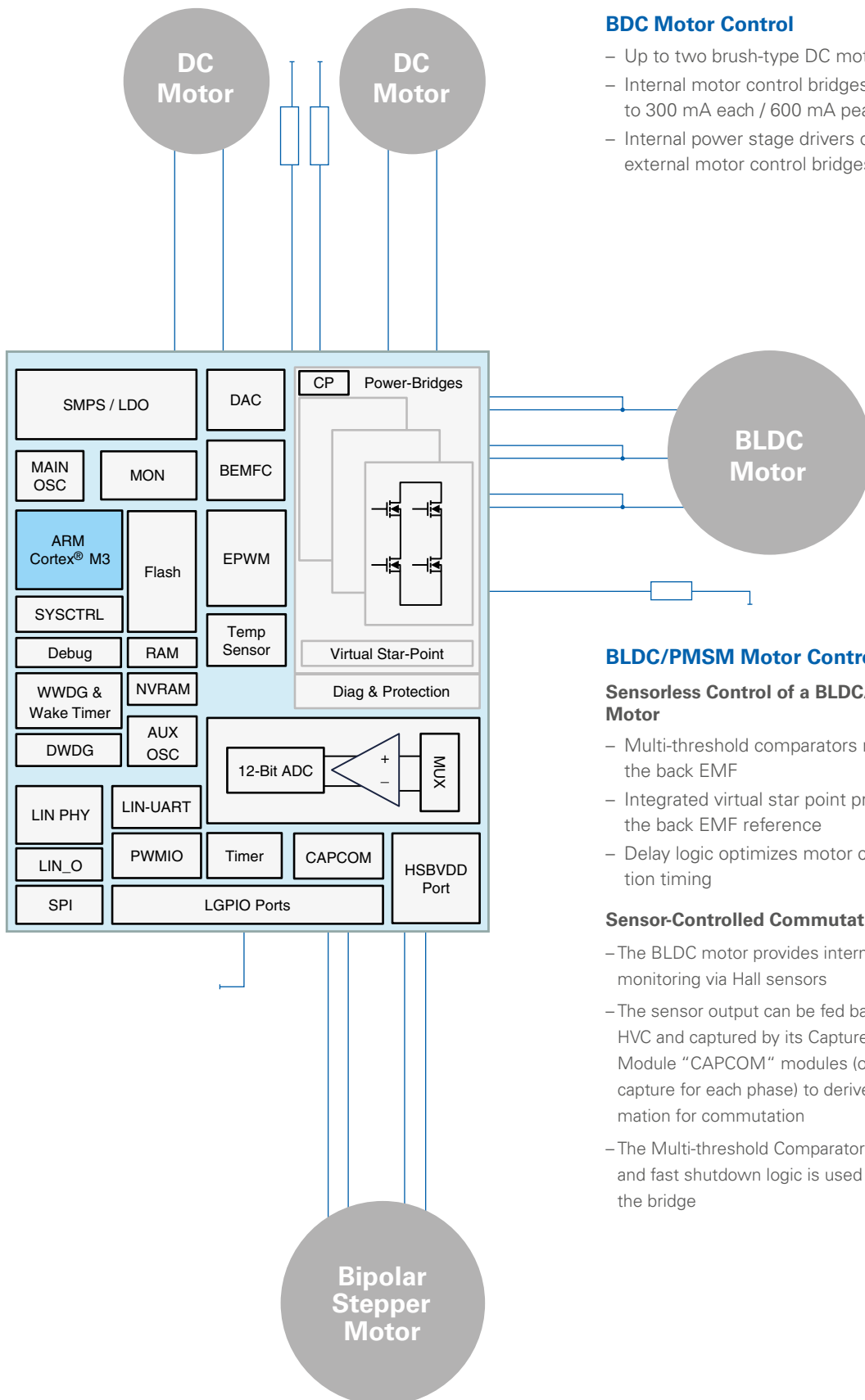

BDC Motor Control

- Up to two brush-type DC motors
- Internal motor control bridges drive up to 300 mA each / 600 mA peak directly
- Internal power stage drivers control external motor control bridges

BLDC/PMSM Motor Control

Sensorless Control of a BLDC/PMSM Motor

- Multi-threshold comparators measure the back EMF
- Integrated virtual star point provides the back EMF reference
- Delay logic optimizes motor commutation timing

Sensor-Controlled Commutation

- The BLDC motor provides internal position monitoring via Hall sensors
- The sensor output can be fed back to the HVC and captured by its Capture/Compare Module "CAPCOM" modules (one input capture for each phase) to derive the information for commutation
- The Multi-threshold Comparator "MTC" and fast shutdown logic is used to protect the bridge

Toolchain for Embedded Controllers

Development Tools

- JTAG Emulator (JEM) with single-wire debug interface
- Application boards
- Micronas SW package with API, core/peripheral drivers, SW templates for motor control functions (e.g. sensored/sensorless 6-step commutation, Space vector modulation...) and application notes
- Integrated development environment with debugger and compilers from several 3rd-party vendors
- Automotive Certified SW-Package ASPICE/ASIL, including EasyGUI for fast implementation of standard parameter sets

Evaluation Boards

- For demonstrations and customer use
- For dedicated applications, e.g. BLDC/Stepper/BDC/PMSM
- HVC-SDB-II (integrated bridges)
- HVC-SDB-III (external bridges)

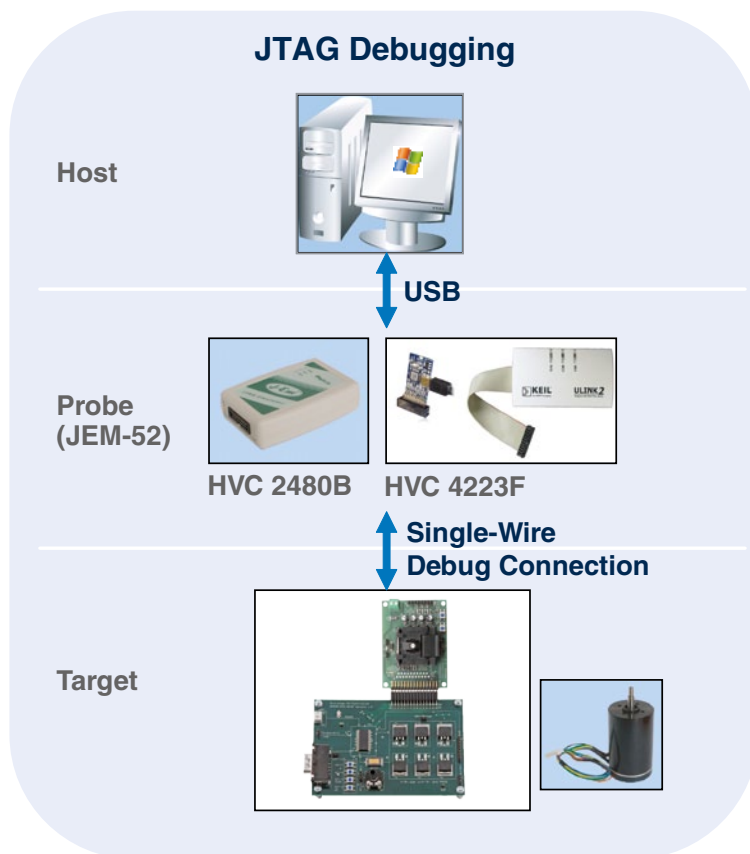

Evaluation Boards

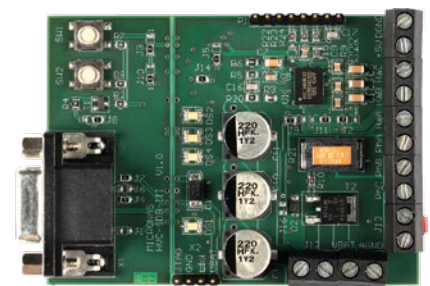

SDB-III (with external bridge)

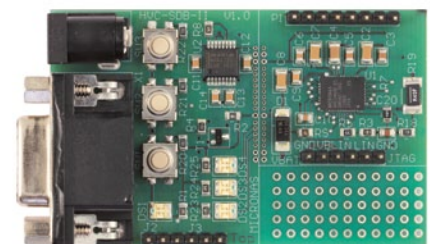

SDB-II (with integrated bridge)

Package Information

TO92UA

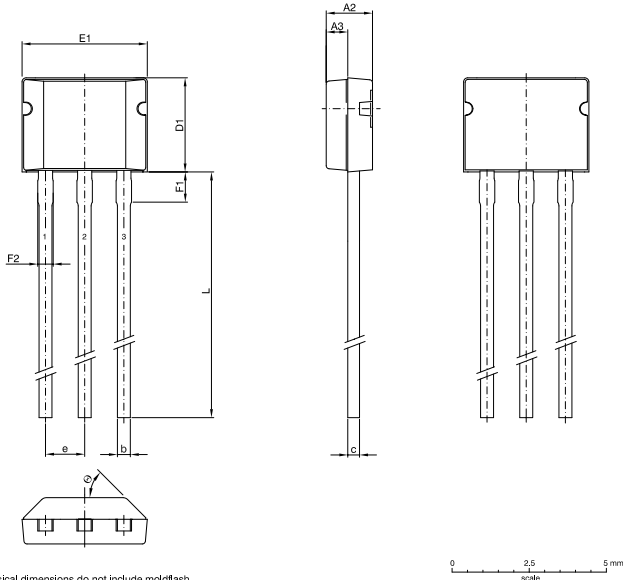

physical dimensions do not include moldflash.

solderability is guaranteed between end of pin and distance F1.

A4, y = these dimensions are different for each sensor type and is specified in the data sheet.
min/max of D1 are specified in the datasheet.

UNIT	A2	A3	b	Bd	c	D1	e	E1	F1	F2	L	φ
mm	1,55 1,45	0,7	0,42	0,2	0,36	3,05	1,27	4,11 4,01	1,2 0,8	0,60 0,42	15,5 min	45°

SOT89

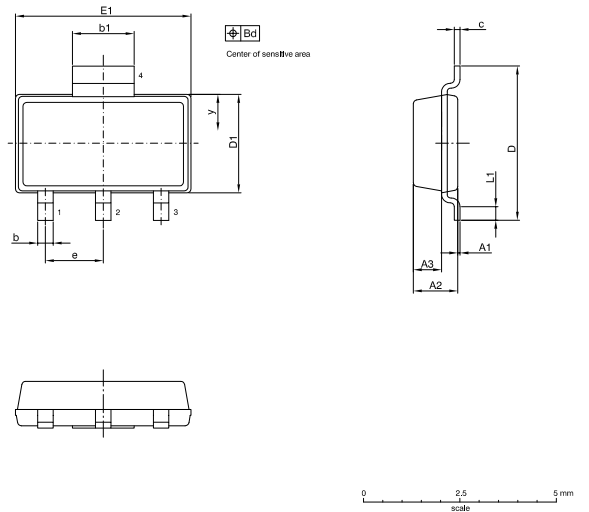

physical dimensions do not include moldflash.

A4, y = these dimensions are different for each sensor type and are specified in the data sheet.

UNIT	A1	A2	A3	b	b1	Bd	c	D	D1	e	E1	L1
mm	0,10 0,02	1,20 1,10	0,73	0,4	1,7	0,2	0,15	4,0	2,6 2,5	1,5	4,6 4,5	0,25 min

TO92UT

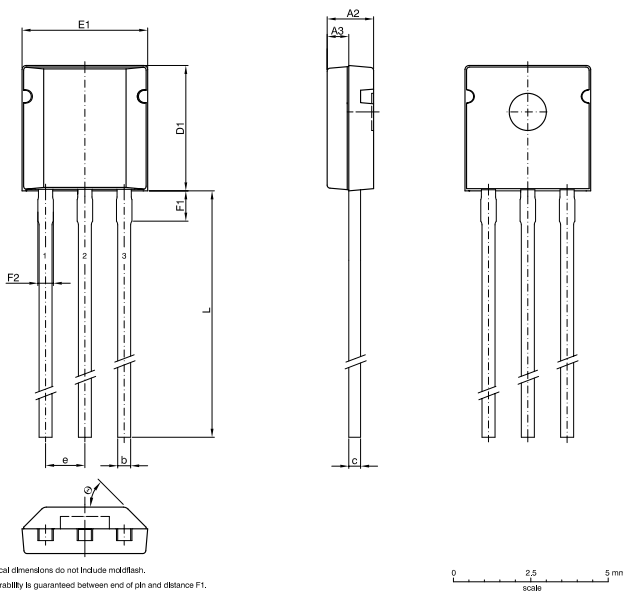

physical dimensions do not include moldflash.

solderability is guaranteed between end of pin and distance F1.

A4, Bd, y = these dimensions are different for each sensor type and are specified in the data sheet.
min/max of D1 are specified in the datasheet.

UNIT	A2	A3	b	c	D1	e	E1	F1	F2	L	φ
mm	1,55 1,45	0,7	0,42	0,36	4,05	1,27	4,11 4,01	1,2 0,8	0,60 0,42	14,5 min	45°

SOT23

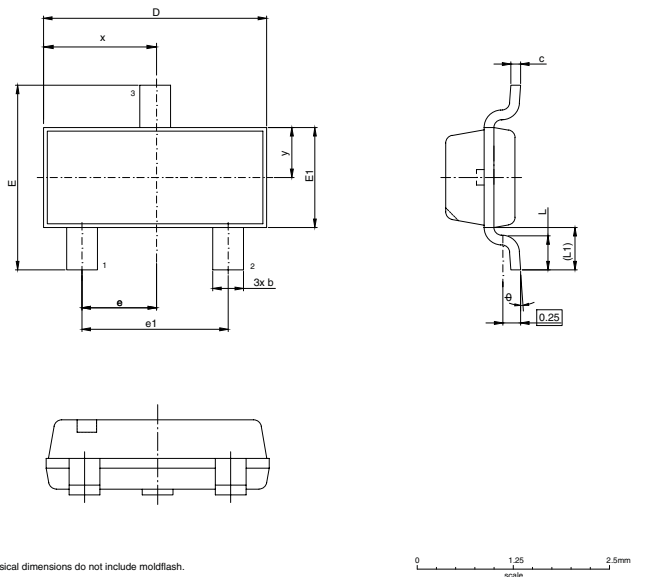

physical dimensions do not include moldflash.

A4, Bd, x, y = these dimensions are different for each sensor type and are specified in the data sheet.

UNIT	A	A1	A2	A3	b	b1	c	c1	D	E	E1	e	e1	L	L1	φ
mm	1,10 max.	0,05 0,10	0,88 1,02	0,5	0,3 0,48	0,3 0,45	0,1 0,18	0,1 0,15	2,8 3,0	2,1 2,5	1,2 1,4	0,95	1,9	0,4 0,6	0,55	0° 8°

Package Information

QFN40 - 6x8

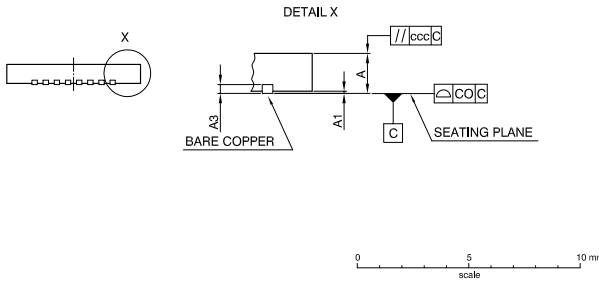
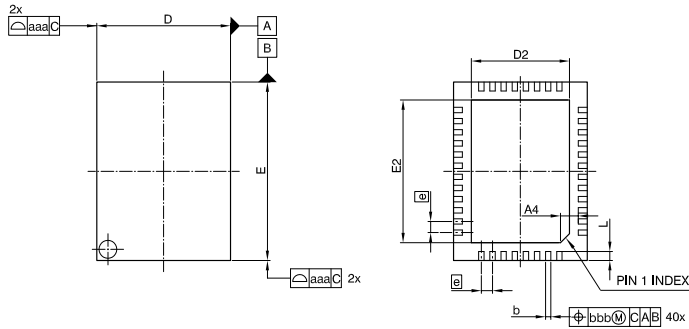

UNIT	A	A1	A3	A4	aaa	b	bbb	ccc	CO	D	D2	E	E2	e	L
mm	1.0 0.8	0.05 0.0	0.2	0.4x45°	0.15	0.3 0.18	0.1	0.1	0.08	6.0	4.2	8.0	6.2	0.5 0.3	

QFN40 - 6x6

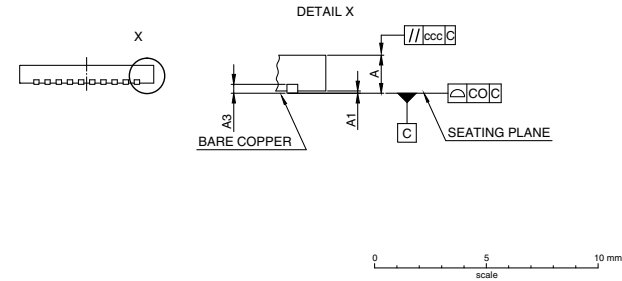
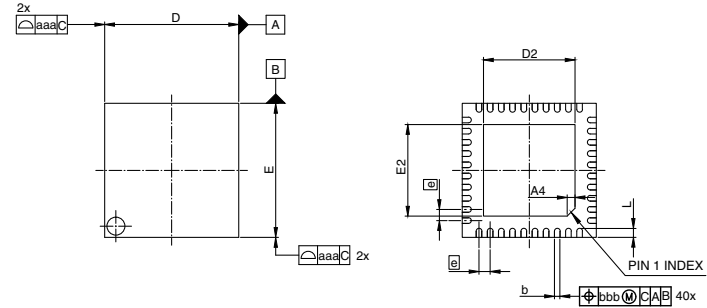

UNIT	A	A1	A3	A4	aaa	b	bbb	ccc	CO	D	D2	E	E2	e	L
mm	0.9 0.8	0.05 0.0	0.2	0.35x45°	0.15	0.3 0.2	0.1	0.1	0.08	6.1 5.9	4.2 4.0	6.1 5.9	4.2 4.0	0.5	0.3

QFN20

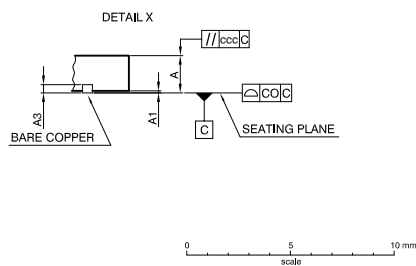
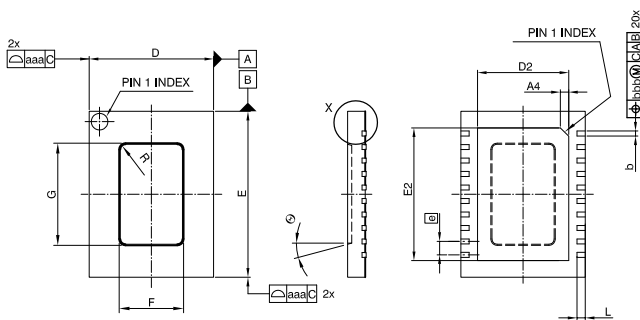

UNIT	A	A1	A3	A4	aaa	b	bbb	ccc	CO	D	D2	E	E2	e	L	F	G	φ	R
mm	1.5 1.3	0.05 0.0	0.2	0.4x45°	0.15	0.35 0.25	0.1	0.1	0.08	6.0	4.2	8.0	6.2	0.65	0.5 0.3	3.7	5.5	15°	0.5

SOIC8

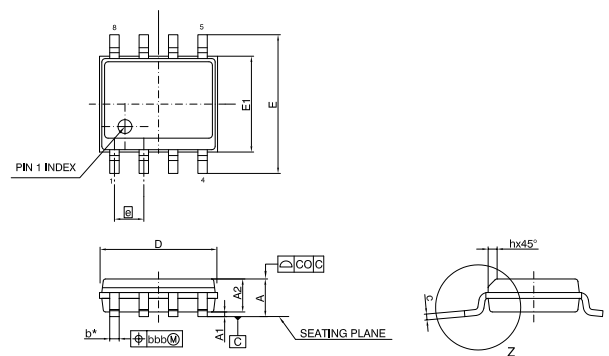

D and *E1* are reference data and do not include mold flash or protrusion. Mold flash or protrusion shall not exceed 150 μm per side.

* does not include dambar protrusion of 0.1 max. per side

A4, Bd, x, y—these dimensions are different for each sensor type and are specified in the data sheet

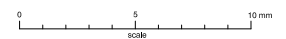

UNIT	A	A1	A2	b	bbb	c	CO	D	E	E1	e	h	L	φ
mm	1.65	0.25 0.1	1.45	0.4	0.25	0.22	0.1	5.0 4.8	6.0	4.0 3.8	1.27	0.3	0.41 min.	8° max.

Package Information

TO92UP 4-pin

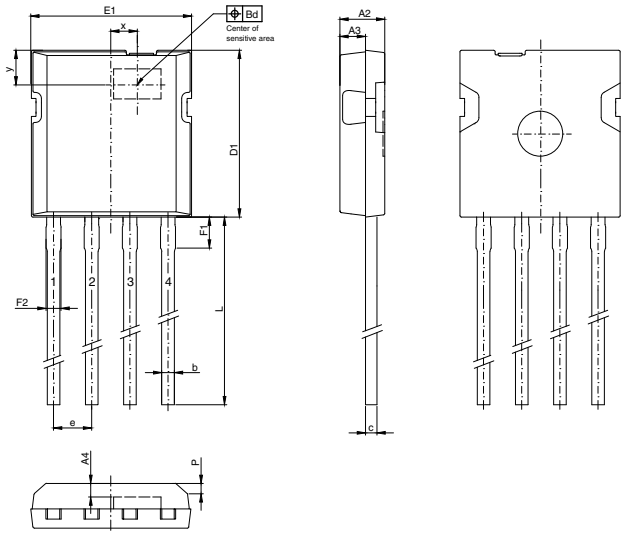

physical dimensions do not include moldflash.
A1, Bd1, x, y—these dimensions are different for each sensor type and are specified in the data sheet.

UNIT	A2	A3	b	c	D1	e	E1	F1	F2	L	P
mm	1.55 1.45	0.85	0.42	0.36	5.60 5.50	1.27	5.38 5.28	1.20 0.80	0.60 0.42	20.0 min	0.3x45°

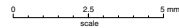

TSSOP14

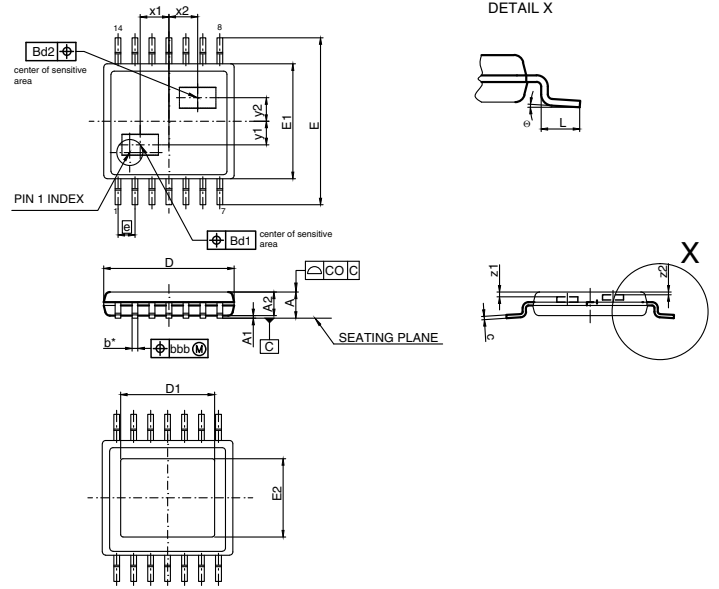

*D1 and "E1" are reference data and do not include mold flash or protrusion.
Mold flash or protrusion shall not exceed 150 μm per side.

* does not include dambar protrusion of 0.1 max. per side

x1, x2, y1, y2, z1, z2, Bd1, Bd2—these dimensions are different for each sensor type and are specified in the data sheet

UNIT	A	A1	A2	b	bbb	c	CO	D	D1	E	E1	E2	e	L	φ
mm	1.1 max.	0.05 0.15	0.85 0.95	0.19 0.30	0.2	0.09 0.20	0.1	4.9 5.1	3.5 3.7	6.4	4.3 4.5	2.9 3.1	0.65	0.5 0.7	8° max.

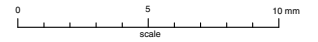

TO92UP 3-pin

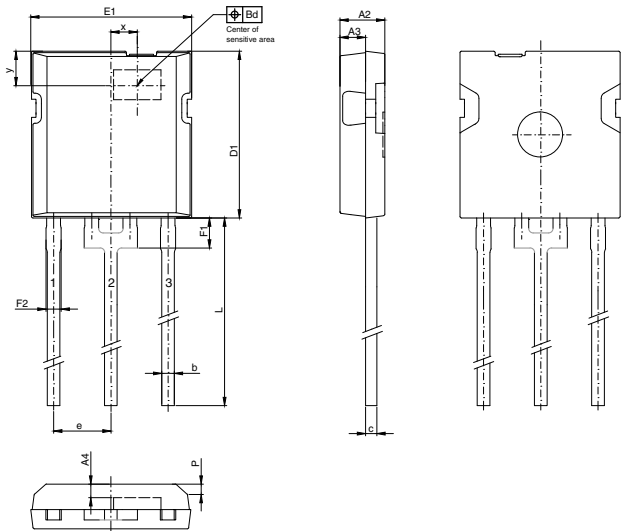

physical dimensions do not include moldflash.
A1, Bd1, x, y—these dimensions are different for each sensor type and are specified in the data sheet.
solderability is guaranteed between end of pin and distance F1.
Sn-thickness might be reduced by mechanical handling.

UNIT	A2	A3	b	c	D1	e	E1	F1	F2	L	P
mm	1.55 1.45	0.85	0.42	0.36	5.60 5.50	1.905	5.38 5.28	1.20 0.80	0.60 0.42	15.0 max	0.3x45°

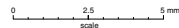

The information and data contained in this brochure are believed to be accurate and reliable. The software and proprietary information contained therein may be protected by copyright, patent, trademark and/or other intellectual property rights of Micronas. All rights not expressly granted remain reserved by Micronas. Micronas assumes no liability for errors and gives no warranty representation or guarantee regarding the suitability of its products for any particular purpose due to these specifications.

By this publication, Micronas does not assume responsibility for patent infringements or other rights of third parties which may result from its use. Commercial conditions, product availability and delivery are exclusively subject to the respective order confirmation.

Any information and data which may be provided in the brochure can and do vary in different applications, and actual performance may vary over time.

All operating parameters must be validated for each customer application by customers' technical experts. Any new issue of this brochure invalidates previous issues. Micronas reserves the right to review this brochure and to make changes to the brochure's content at any time without obligation to notify any person or entity of such revision or changes. For further advice please contact us directly.

Do not use our products in life-supporting systems, military, aviation, or aerospace applications! Unless explicitly agreed to otherwise in writing between the parties, Micronas' products are not designed, intended or authorized for use as components in systems intended for surgical implants into the body, or other applications intended to support or sustain life, or for any other application in which the failure of the product could create a situation where personal injury or death could occur.

Micronas Trademarks

- HAL
- varioHAL
- 1D HAL
- 2D HAL
- 3D HAL
- easyLIN
- zero ppm
- mySENS



Micronas Group

Headquarters

Micronas Semiconductor Holding AG
Technopark
Technoparkstrasse 1
8005 Zurich
Switzerland
Phone +41 44 445 3960
Fax +41 44 445 3961

Operational Headquarters

Micronas GmbH
Hans-Bunte-Strasse 19
79108 Freiburg
Germany
Phone +49 761 517 0
Fax +49 761 517 2174
info@micronas.com



Sales Offices

Germany

Micronas GmbH
Hans-Bunte-Strasse 19
79108 Freiburg
P.O. Box 840
79008 Freiburg
Phone +49 761 517-0
Fax +49 761 517-2174
sales.germany@micronas.com

Micronas New Technologies GmbH
Muenchener Strasse 11
85540 Haar/Munich
Phone +49 761 517-4711
Fax +49 761 5171-4711
sales.germany@micronas.com

USA

Micronas GmbH,
Representative: Delta Management
Group, LLCs
735 Burroughs Street,
Plymouth
MI 48170
Phone +1 248 346 0808
sales.america@micronas.com

China

Micronas GmbH,
Representative Office Shanghai
Rm 2623, Building A
Gateway International Plaza
325 Tian Yao Qiao Rd
Shanghai 200030
Phone +86 21 33632749
Fax +86 21 33632746
yi.yang@micronas.com

France

Micronas GmbH,
Representative France
Mr. Marc Ferry-Chappuis
21 rue Vauvenargues
75018 Paris
Phone +33 60 9500221
salesEMEA@micronas.com

Japan

Micronas Japan Ltd.
7F NAGAI Memorial Hall
The Pharmaceutical Society of Japan
2-12-15, Shibuya, Shibuya-ku
Tokyo 150-0002
Phone +81 3 5464-1620
Fax +81 3 5464-1649
sales.japan@micronas.com

Korea

Micronas GmbH,
Representative Korea
Mr. Seung Young Youm
ARA Incubating Business Center,
S-#906
H-Square, Pangyo Techno Valley
680 Sampyeong-dong,
Seongnam-si, Bundang-gu
Phone +82 10 5494 3356
saleskorea@micronas.com

Micronas GmbH

Hans-Bunte-Strasse 19 | 79108 Freiburg | Germany
Phone +49 761 517-0 | Fax +49 761 517-2174

info@micronas.com

www.micronas.com